



SIP Cordless Series Master User Guide

Models:

- SIP classic trimstyle 1-line hotel telephone - S1310,
- SIP classic trimstyle 2-line hotel telephone - S1320,
- SIP classic cordless 1-line hotel telephone - S1410,
- SIP classic cordless 2-line hotel telephone - S1420,
- SIP classic charging base - C3300,
- SIP classic cordless 1-line accessory handset - C3400,
- SIP classic cordless 2-line accessory handset - C3500,
- SIP contemporary trimstyle 1-line hotel telephone - S2310/S2310-6VDC,
- SIP contemporary trimstyle 2-line hotel telephone - S2320/S2320-6VDC,
- SIP contemporary cordless 1-line hotel telephone - S2410/CTM-S2411,
- SIP contemporary cordless 2-line hotel telephone - S2420/CTM-S2421,
- SIP contemporary charging base - C4300,
- SIP contemporary charging stand - C4310,
- SIP contemporary cordless 1-line accessory handset - C4400/CTM-C4401,
- SIP contemporary cordless 2-line accessory handset - C4500/CTM-C4501,
- SIP contemporary cordless 1-line accessory Petite™ - CTM-S241P,
- SIP contemporary cordless 2-line accessory Petite™ - CTM-S242P,
- SIP contemporary cordless 1-line accessory handset and charger bundle - CTM-S241HS,
- SIP contemporary cordless 2-line accessory handset and charger bundle - CTM-S242HS,
- SIP contemporary cordless 1-line accessory handset with speed dials and charger bundle - CTM-S241SD, and
- SIP contemporary cordless 2-line accessory handset with speed dials and charger bundle - CTM-S242SD

Important safety instructions

When using your telephone equipment, basic safety precautions should always be followed to reduce the risk of fire, electric shock and injury, including the following:

1. This product should be installed by a qualified technician.
2. This product should only be connected to the host equipment and never directly to the network such as Public Switch Telephone Network (PSTN) or Plain Old Telephone Services (POTS).
3. Read and understand all instructions.
4. Follow all warnings and instructions marked on the product.
5. Unplug this product from the wall outlet before cleaning. Do not use liquid or aerosol cleaners. Use a damp cloth for cleaning.
6. Do not use this product near water such as near a bath tub, wash bowl, kitchen sink, laundry tub or swimming pool, or in a wet basement or shower.
7. Do not place this product on an unstable table, shelf, stand or other unstable surfaces.
8. Slots and openings in the back or bottom of the telephone base and handset are provided for ventilation. To protect them from overheating, these openings must not be blocked by placing the product on a soft surface such as a bed, sofa or rug. This product should never be placed near or over a radiator or heat register. This product should not be placed in any area where proper ventilation is not provided.
9. This product should be operated only from the type of power source indicated on the marking label. If you are not sure of the type of power supply on the premises, consult your dealer or local power company.
10. Do not allow anything to rest on the power cord. Do not install this product where the cord may be walked on.
11. Never push objects of any kind into this product through the slots in the telephone base or handset because they may touch dangerous voltage points or create a short circuit. Never spill liquid of any kind on the product.
12. To reduce the risk of electric shock, do not disassemble this product, but take it to an authorized service facility. Opening or removing parts of the telephone base or handset other than specified access doors may expose you to dangerous voltages or other risks. Incorrect reassembling can cause electric shock when the product is subsequently used.
13. Do not overload wall outlets and extension cords.
14. Unplug this product from the wall outlet and refer servicing to an authorized service facility under the following conditions:
 - A. When the power supply cord or plug is damaged or frayed.
 - B. If liquid has been spilled onto the product.
 - C. If the product has been exposed to rain or water.
 - D. If the product does not operate normally by following the operating instructions. Adjust only those controls that are covered by the operation instructions. Improper adjustment of other controls may result in damage and often requires extensive work by an authorized technician to restore the product to normal operation.
 - E. If the product has been dropped and the telephone base and/or handset has been damaged.
 - F. If the product exhibits a distinct change in performance.
15. Avoid using a telephone (other than cordless) during an electrical storm. There is a remote risk of electric shock from lightning.
16. Do not use the telephone to report a gas leak in the vicinity of the leak. Under certain circumstances, a spark may be created when the adapter is plugged into the power outlet, or when the handset is replaced in its cradle. This is a common event associated with the closing of any electrical circuit. The user should not plug the phone into a power outlet, and should not put a charged handset into the cradle, if the phone is located in an environment containing concentrations of flammable or flame-supporting gases, unless there is adequate ventilation. A spark in such an environment could create a fire or explosion. Such environments might include: medical use of oxygen without adequate ventilation; industrial gases (cleaning solvents; gasoline vapors; etc.); a leak of natural gas; etc.
17. Only put the handset of your telephone next to your ear when it is in normal talk mode.
18. The power adapters are intended to be correctly oriented in a vertical or floor mount position. The prongs are not designed to hold the plug in place if it is plugged into a ceiling, under-the-table or cabinet outlet.
19. Use only the power cord and batteries indicated in this manual. Do not dispose of batteries in a fire. They may explode. Check with local codes for possible special disposal instructions.
20. In wall mounting position, make sure to mount the telephone base on the wall by aligning the eyelets with the mounting studs of the wall plate. Then slide the telephone base down on both mounting studs until it locks into place. Refer to the full instructions in **Installation** in the user's manual.
21. **CAUTION:** Keep small metallic objects such as pins and staples away from the handset receiver.
22. **CAUTION:** There may be a risk of explosion if a wrong type of handset battery is used (S1410, S1420, S2410, S2420, C3400, C3500, C4400, C4500, CTM-S241HS, CTM-S242HS, CTM-S241SD, CTM-242SD, CTM-S2411, CTM-S2421, CTM-C4401 and CTM-C4501). Use only the supplied rechargeable battery (BT264392/BT266342) or replacement battery (BT266342). Dispose of used batteries according to the information in **The RBRC® seal** in the user's manual.
23. The equipment is to be supplied from an identified USB port complying with the requirements of Limited Power Source.

SAVE THESE INSTRUCTIONS

Table of contents



































Parts checklist	1
Telephone layout	4
SIP classic trimstyle 1-line - S1310	4
SIP classic trimstyle 2-line - S1320.....	5
SIP classic cordless 1-line - S1410	6
SIP classic cordless 2-line - S1420.....	7
SIP classic charging base - C3300.....	8
SIP classic cordless 1-line accessory handset - C3400	9
SIP classic cordless 2-line accessory handset - C3500	10
SIP contemporary trimstyle 1-line - S2310/S2310-6VDC	11
SIP contemporary trimstyle 2-line - S2320/S2320-6VDC.....	12
SIP contemporary cordless 1-line - S2410.....	13
SIP contemporary cordless 1-line - CTM-S2411	14
SIP contemporary cordless 1-line accessory Petite - CTM-S241P	15
SIP contemporary cordless 2-line - S2420.....	16
SIP contemporary cordless 2-line - CTM-S2421	17
SIP contemporary cordless 2-line accessory Petite - CTM-S242P	18
SIP contemporary charging base - C4300	19
SIP contemporary charging stand - C4310.....	20
SIP contemporary cordless 1-line accessory handset - C4400	21
SIP contemporary cordless 1-line accessory handset - CTM-C4401	22
SIP contemporary cordless 2-line accessory handset - C4500	23
SIP contemporary cordless 2-line accessory handset - CTM-C4501	24
SIP contemporary cordless 1-line accessory handset and charger bundle - CTM-S241HS.....	25
SIP contemporary cordless 2-line accessory handset and charger bundle - CTM-S242HS	26
SIP contemporary cordless 1-line accessory handset with speed dials and charger bundle - CTM-S241SD.....	27
SIP contemporary cordless 2-line accessory handset with speed dials and charger bundle - CTM-S242SD	28
Installation	29
SIP classic trimstyle 1-line/2-line - S1310/S1320	29
SIP classic cordless 1-line/2-line - S1410/S1420	32
SIP classic charging base - C3300.....	35
SIP classic cordless 1-line/2-line accessory handset - C3400/C3500	36
SIP contemporary trimstyle 1-line/2-line - S2310/S2320	37
SIP contemporary trimstyle 1-line/2-line - S2310-6VDC/S2320-6VDC	39
SIP contemporary trimstyle 1-line/2-line - S2310/S2310-6VDC/S2320/S2320-6VDC	41
SIP contemporary cordless 1-line/2-line - S2410/CTM-S2411/S2420/CTM-S2421	42
SIP contemporary cordless 1-line/2-line - S2410/S2420.....	44
SIP contemporary cordless 1-line/2-line - CTM-S2411/CTM-S2421	46
SIP contemporary cordless 1-line/2-line accessory Petite - CTM-S241P/CTM-S242P	48
SIP contemporary charging base - C4300	51
SIP contemporary charging stand - C4310.....	52
SIP contemporary cordless 1-line/2-line accessory handset - C4400/C4500/CTM-S241HS/CTM-S242HS	53
SIP contemporary cordless 1-line/2-line accessory handset - CTM-C4401/CTM-C4501/CTM-S241SD/CTM-S242SD.....	55
Telephone settings	57
SIP classic trimstyle - S1310/S1320.....	57
SIP classic cordless 1-line/2-line - S1410/S1420	57
SIP contemporary trimstyle - S2310/S2310-6VDC/S2320/S2320-6VDC	57
SIP contemporary cordless 1-line/2-line - S2410/CTM-S2411/S2420/CTM-S2421	57
SIP contemporary cordless 1-line/2-line accessory Petite - CTM-S241P/CTM-S242P	57
Telephone operation	58
SIP classic trimstyle 1-line - S1310	58
SIP classic trimstyle 2-line - S1320.....	59
SIP classic cordless 1-line - S1410	61
SIP classic cordless 2-line - S1420	63
SIP contemporary trimstyle 1-line - S2310/S2310-6VDC	66
SIP contemporary trimstyle 2-line - S2320/S2320-6VDC	68
SIP contemporary cordless 1-line - S2410/CTM-S2411	70
SIP contemporary cordless 1-line accessory Petite - CTM-S241P	73
SIP contemporary cordless 2-line - S2420/CTM-S2421	74
SIP contemporary cordless 2-line accessory Petite - CTM-S242P.....	77

Table of contents

Appendix	79
Troubleshooting.....	79
Precautions for users of implanted cardiac pacemakers.....	81
Operating range.....	81
About cordless telephones	81
The RBRC® seal	81
VTech Hospitality limited warranty program	82
FCC, ACTA and IC regulations	83
Energy-saving charging mode	84
Maintenance	84
Technical specifications	85
Index	89









































Parts checklist

Items contained in the respective telephone package:

Model name	Model number	Parts included
SIP classic trimstyle 1-line	S1310	 Telephone base  Corded handset  Mounting bracket with a screw  Cat-5 network cables (2)
SIP classic trimstyle 2-line	S1320	 Telephone base  Corded handset  Mounting bracket with a screw  Cat-5 network cables (2)
SIP classic cordless 1-line	S1410	 Telephone base with faceplate and overlay  Cordless handset  Battery  Screw  Cat-5 network cable
SIP classic cordless 2-line	S1420	 Telephone base with faceplate and overlay  Cordless handset  Battery  Screw  Cat-5 network cable
SIP classic charging base	C3300	 Charging base  Mounting bracket with a screw  Cat-5 network cable
SIP classic cordless 1-line accessory handset	C3400	 Cordless handset  Battery  Screw
SIP classic cordless 2-line accessory handset	C3500	 Cordless handset  Battery  Screw
SIP contemporary trimstyle 1-line	S2310	 Telephone base  Corded handset  Mounting bracket with a screw  Cat-5 network cables (2)
SIP contemporary trimstyle 1-line	S2310-6VDC	 Telephone base  Corded handset  Mounting bracket with a screw  Telephone base power adapter





































Parts checklist

Items contained in the respective telephone package:

Model name	Model number	Parts included
SIP contemporary trimstyle 2-line	S2320	 Telephone base  Corded handset  Mounting bracket with a screw  Cat-5 network cables (2)
SIP contemporary trimstyle 2-line	S2320-6VDC	 Telephone base  Corded handset  Mounting bracket with a screw  Telephone base power adapter
SIP contemporary cordless 1-line	S2410	 Telephone base with faceplate and overlay  Cordless handset  Mounting bracket with a screw  Battery  Screw  Cat-5 network cable
SIP contemporary cordless 1-line	CTM-S2411	 Telephone base with faceplate and overlay  Cordless handset  Mounting bracket with a screw  Battery  Screws (2)  Cat-5 network cable
SIP contemporary cordless 1-line accessory Petite	CTM-S241P	 Telephone base with faceplate and overlay  Corded handset  Mounting bracket  Power adapter
SIP contemporary cordless 2-line	S2420	 Telephone base with faceplate and overlay  Cordless handset  Mounting bracket with a screw  Battery  Screw  Cat-5 network cable
SIP contemporary cordless 2-line	CTM-S2421	 Telephone base with faceplate and overlay  Cordless handset  Mounting bracket  Battery  Screws (2)  Cat-5 network cable
SIP contemporary cordless 2-line accessory Petite	CTM-S242P	 Telephone base with faceplate and overlay  Corded handset  Mounting bracket  Power adapter

Parts checklist

Items contained in the respective telephone package:

Model name	Model number	Parts included
SIP contemporary charging base	C4300	   Charging base Mounting bracket with a screw Cat-5 network cable
SIP contemporary charging stand	C4310	  Charging stand Cat-5 network cable
SIP contemporary cordless 1-line accessory handset	C4400	   Cordless handset Battery Screw
SIP contemporary cordless 1-line accessory handset	CTM-C4401	   Cordless handset Battery Screw
SIP contemporary cordless 2-line accessory handset	C4500	   Cordless handset Battery Screw
SIP contemporary cordless 2-line accessory handset	CTM-C4501	   Cordless handset Battery Screw
SIP contemporary cordless 1-line accessory handset and charger bundle	CTM-S241HS	     Cordless handset Battery Screw Charging stand Power adapter
SIP contemporary cordless 2-line accessory handset and charger bundle	CTM-S242HS	     Cordless handset Battery Screw Charging stand Power adapter
SIP contemporary cordless 1-line accessory handset with speed dials and charger bundle	CTM-S241SD	     Cordless handset Battery Screw Charging stand Power adapter
SIP contemporary cordless 2-line accessory handset with speed dials and charger bundle	CTM-S242SD	     Cordless handset Battery Screw Charging stand Power adapter

Telephone layout

SIP classic trimstyle 1-line - S1310

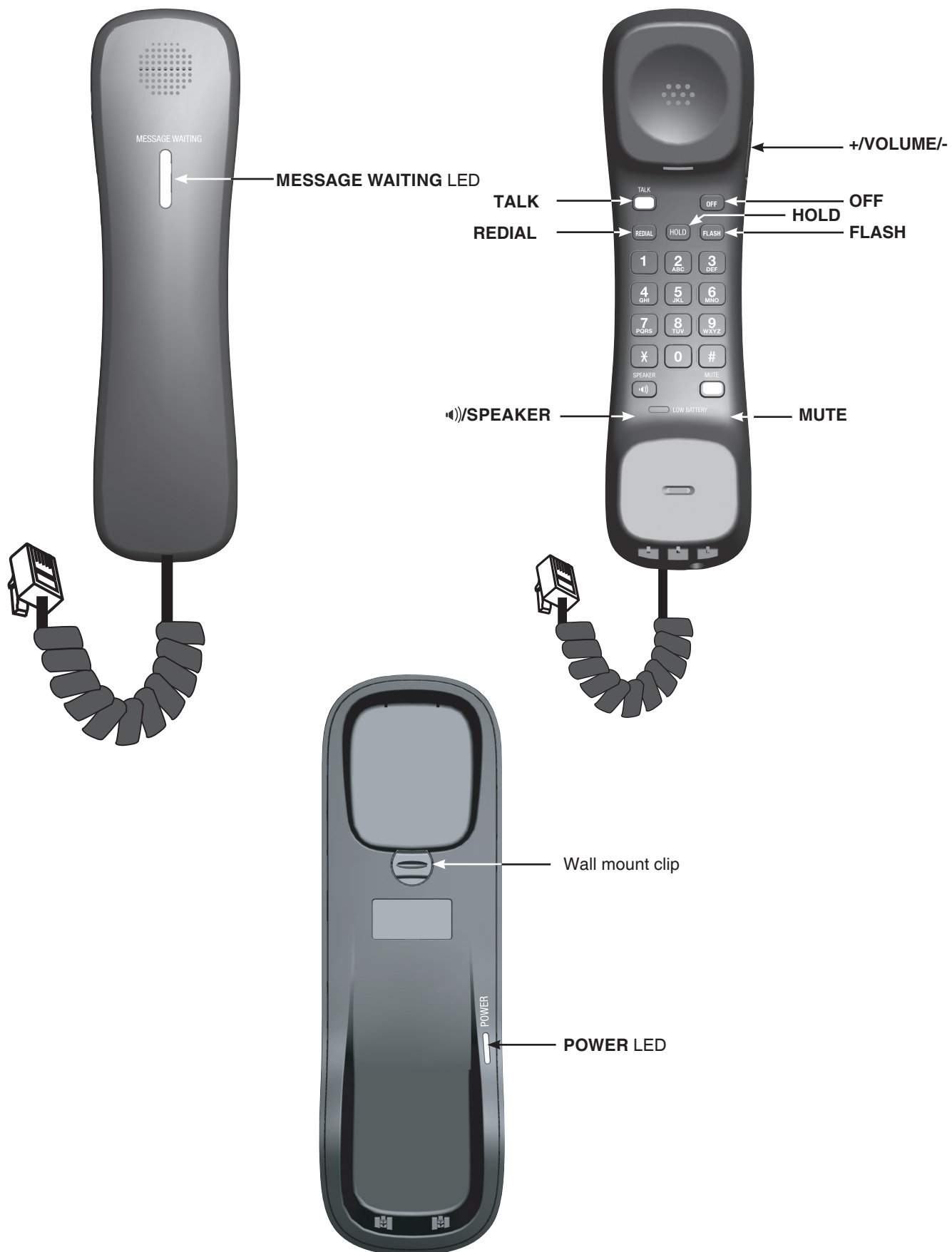

Telephone layout

SIP classic trimstyle 2-line - S1320

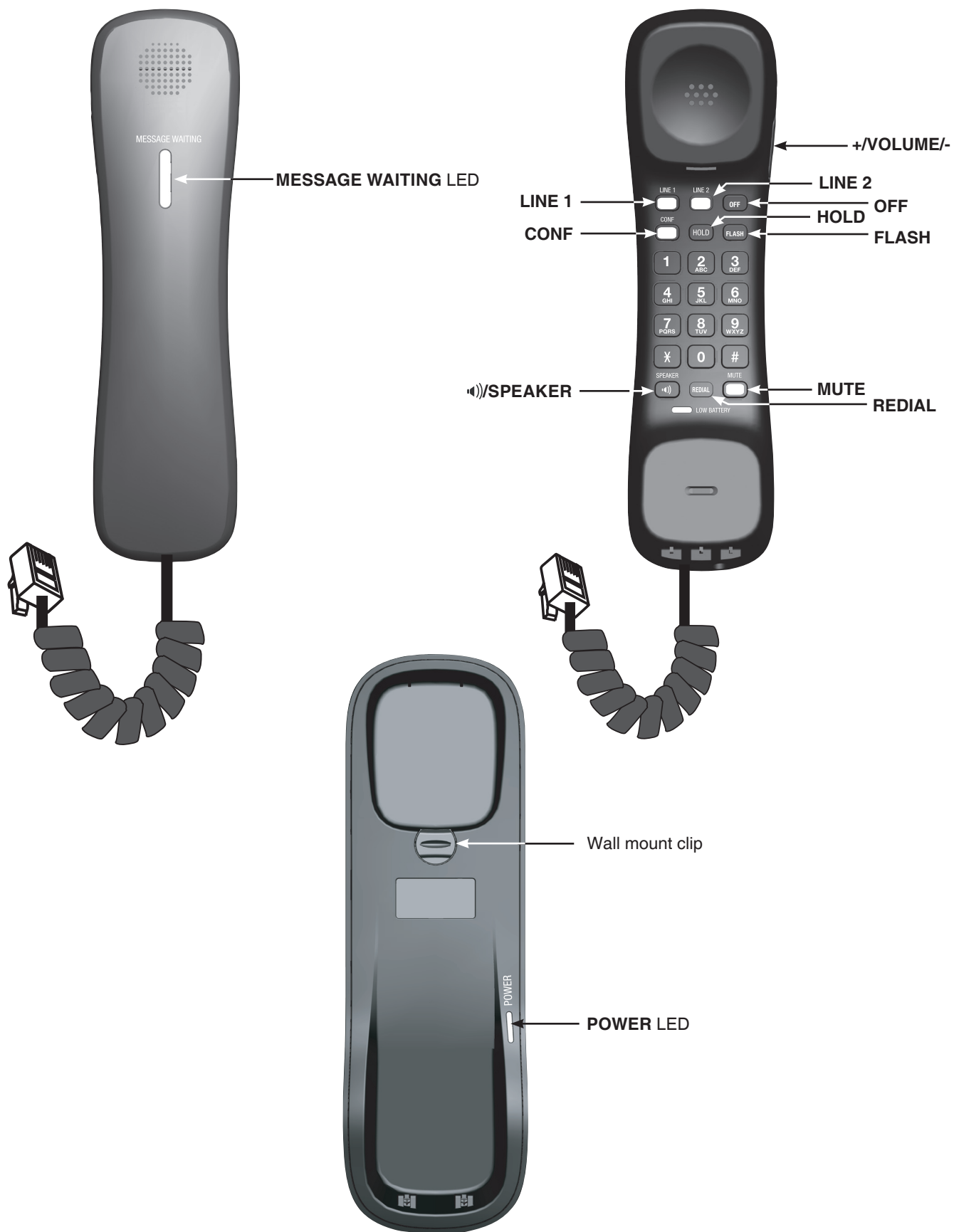

Telephone layout

Telephone layout

SIP classic cordless 1-line - S1410

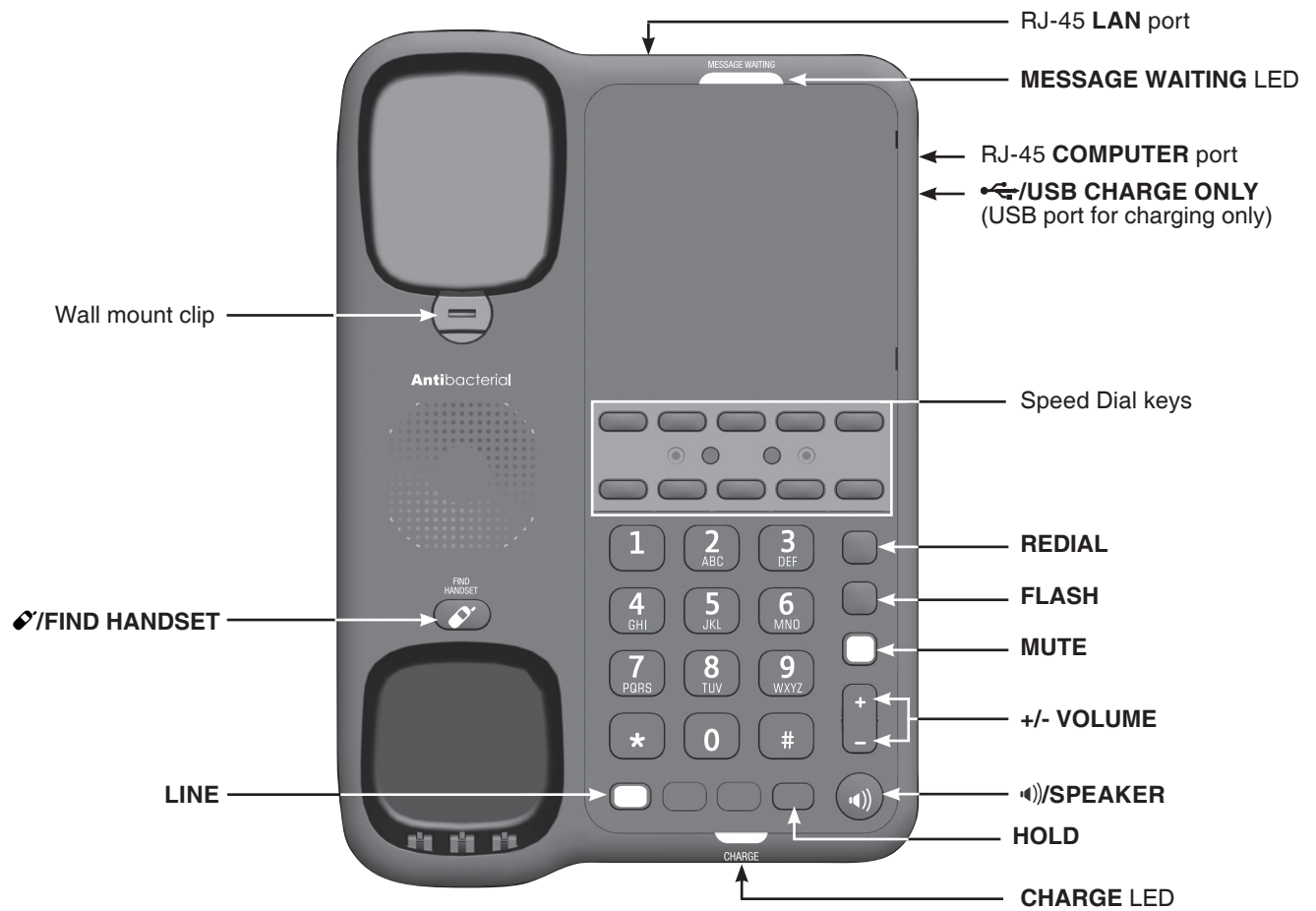

Telephone layout

SIP classic cordless 2-line - S1420

Telephone layout

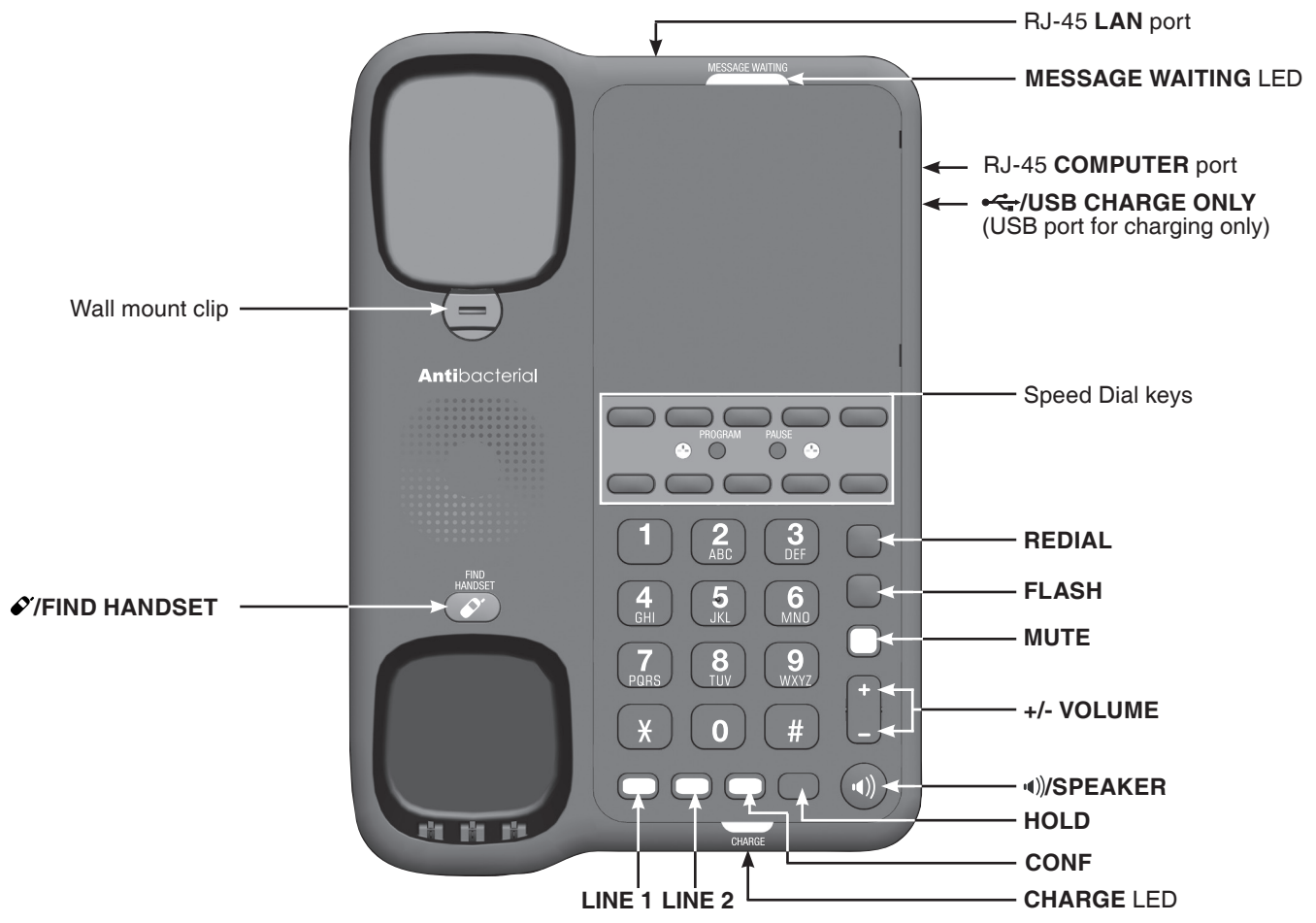

Telephone layout

SIP classic charging base - C3300

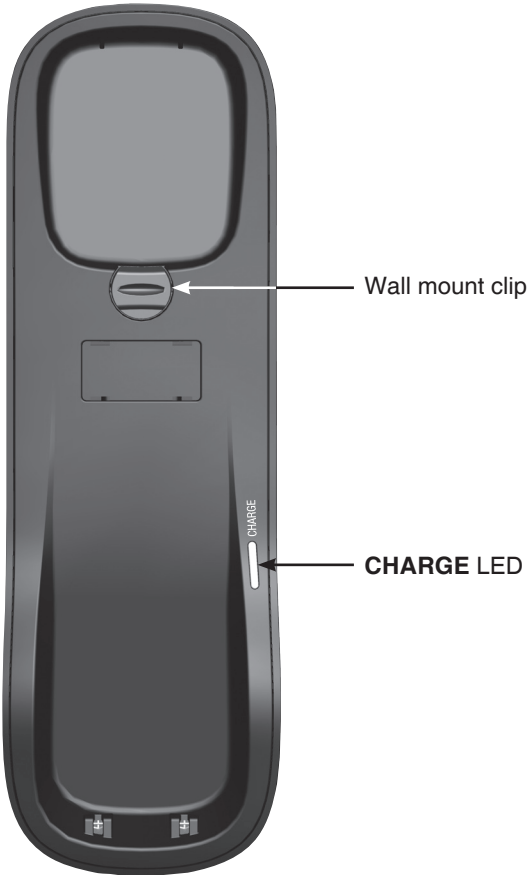

Telephone layout

SIP classic cordless 1-line accessory handset - C3400



Telephone layout

Telephone layout

SIP classic cordless 2-line accessory handset - C3500

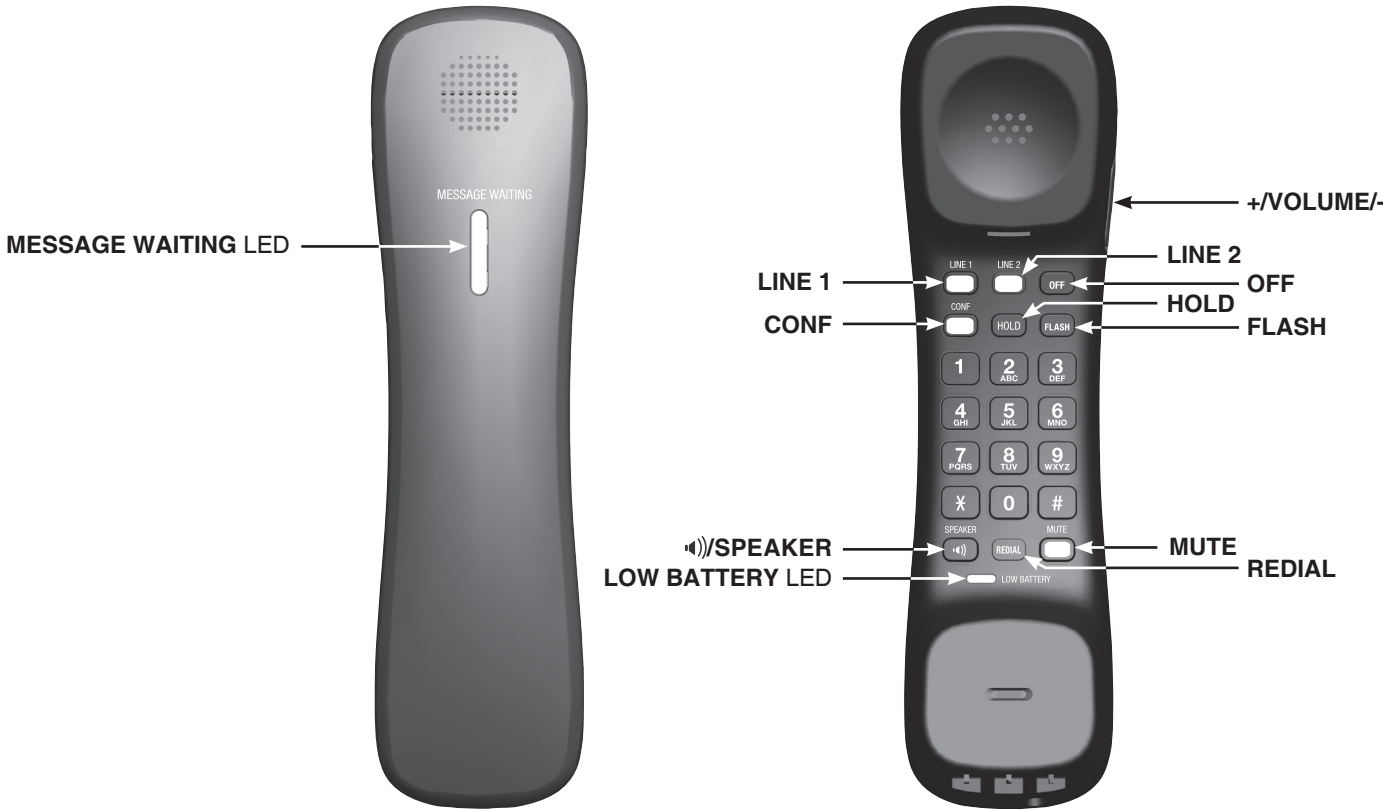

Telephone layout

SIP contemporary trimstyle 1-line - S2310/S2310-6VDC

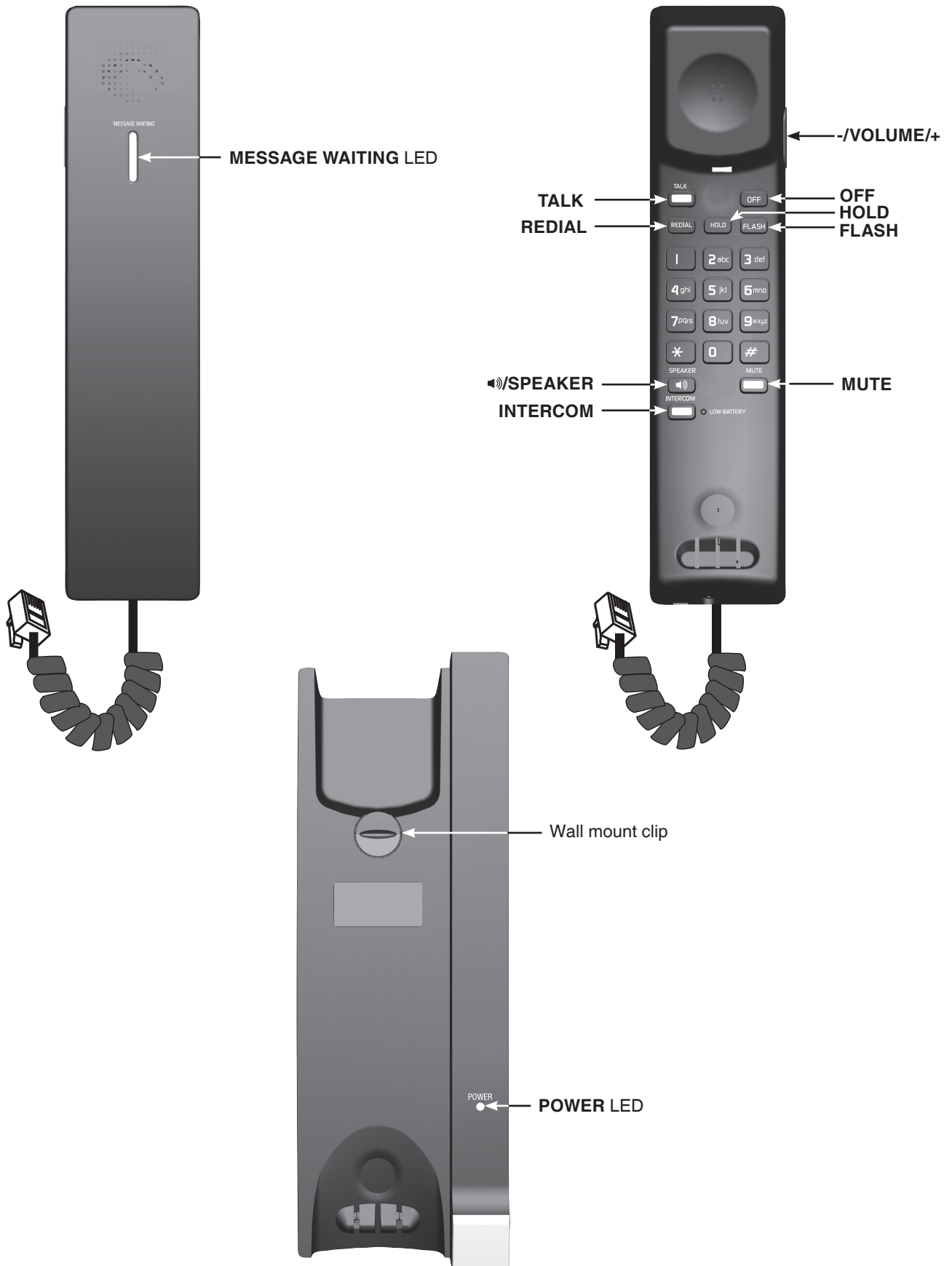

Telephone layout

SIP contemporary trimstyle 2-line - S2320/S2320-6VDC

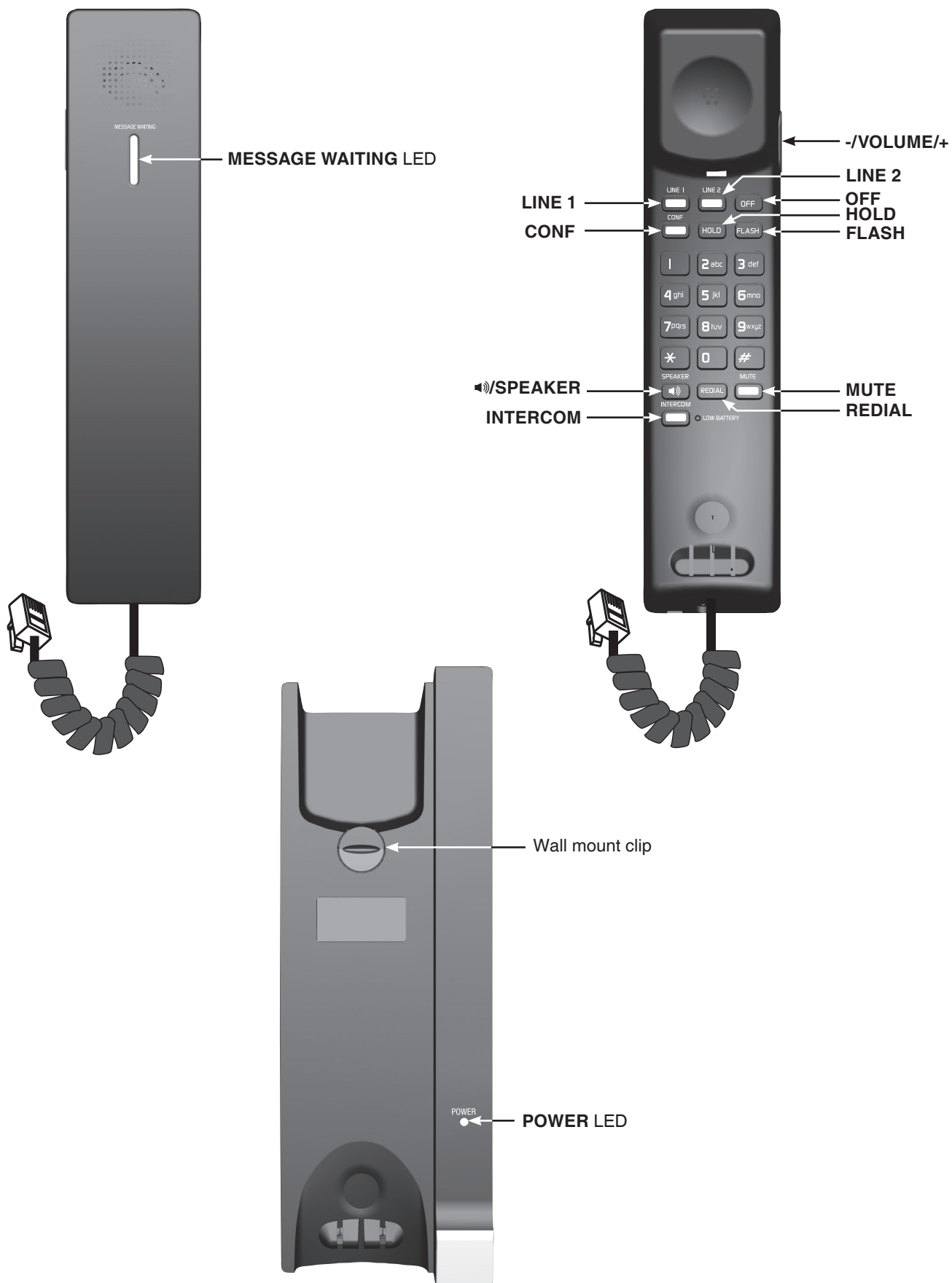

Telephone layout

SIP contemporary cordless 1-line - S2410

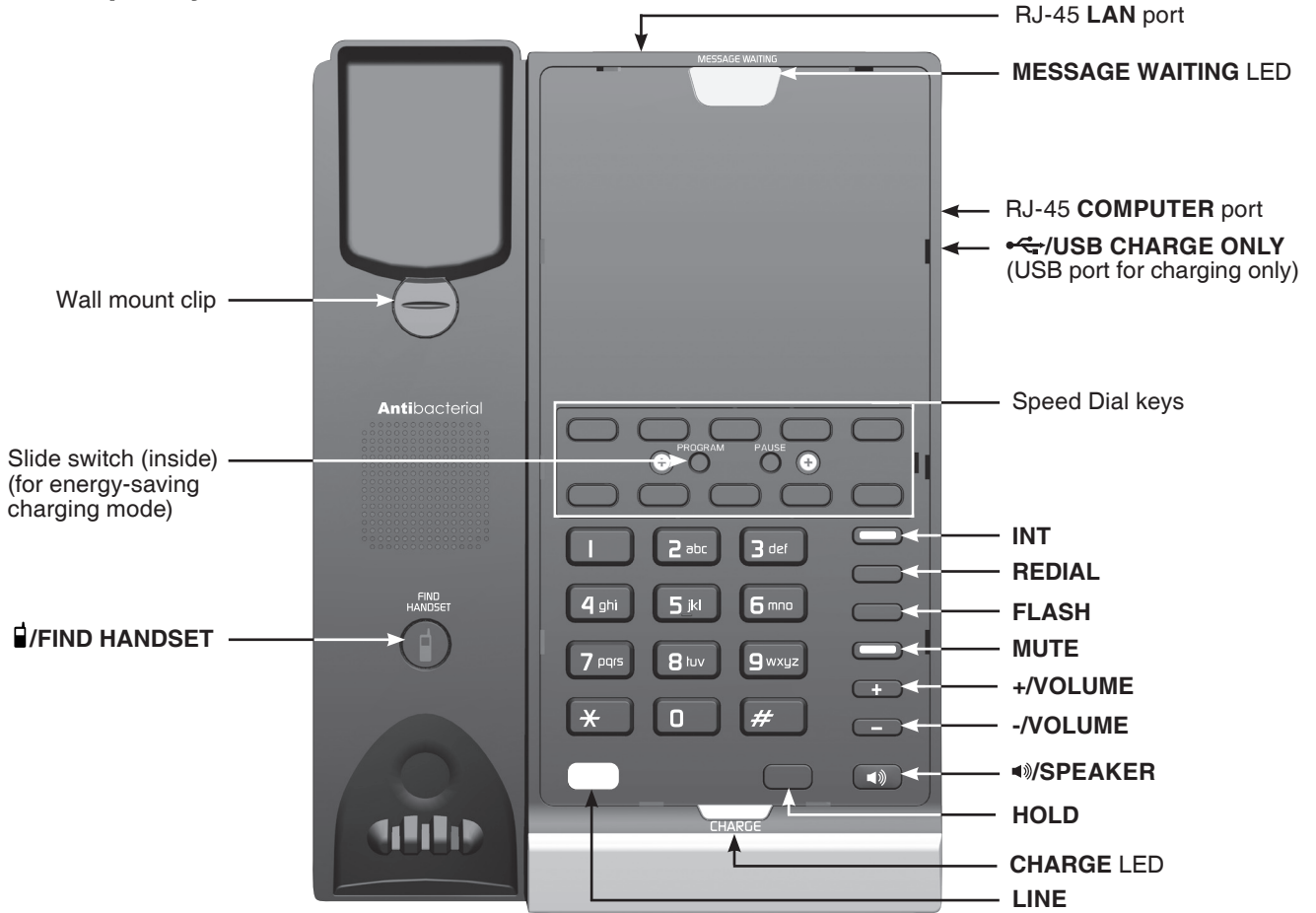

Telephone layout

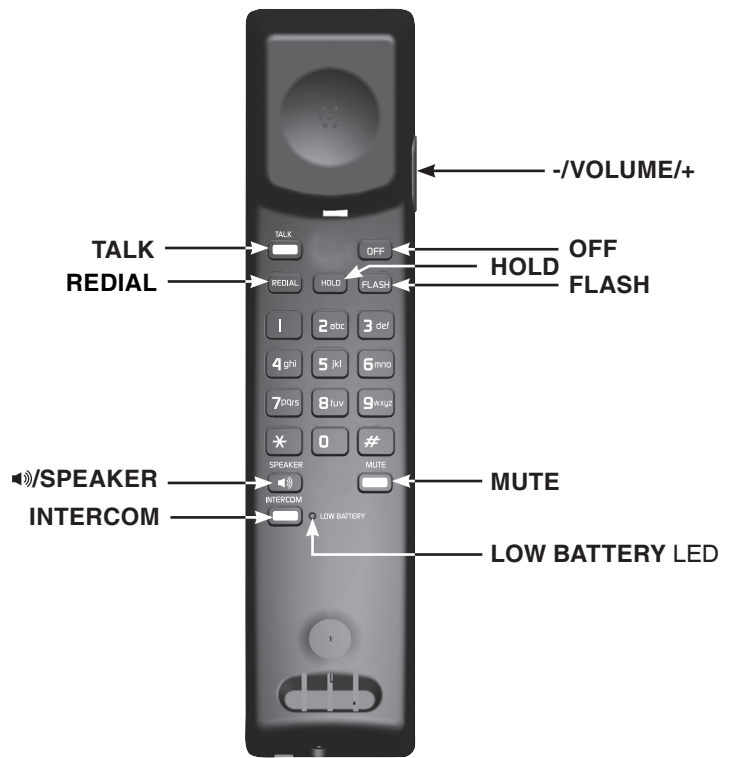
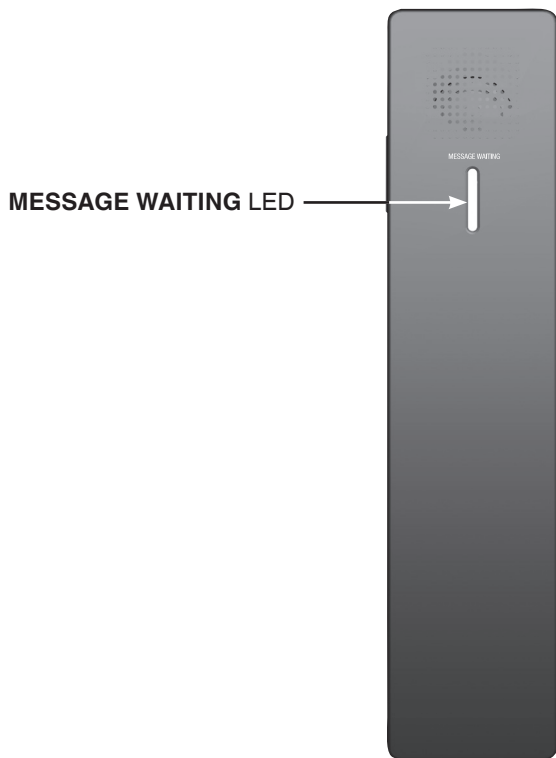

NOTE: Keep the slide switch (inside the phone) on the left side to maintain normal telephone operation.

Telephone layout

SIP contemporary cordless 1-line - CTM-S2411

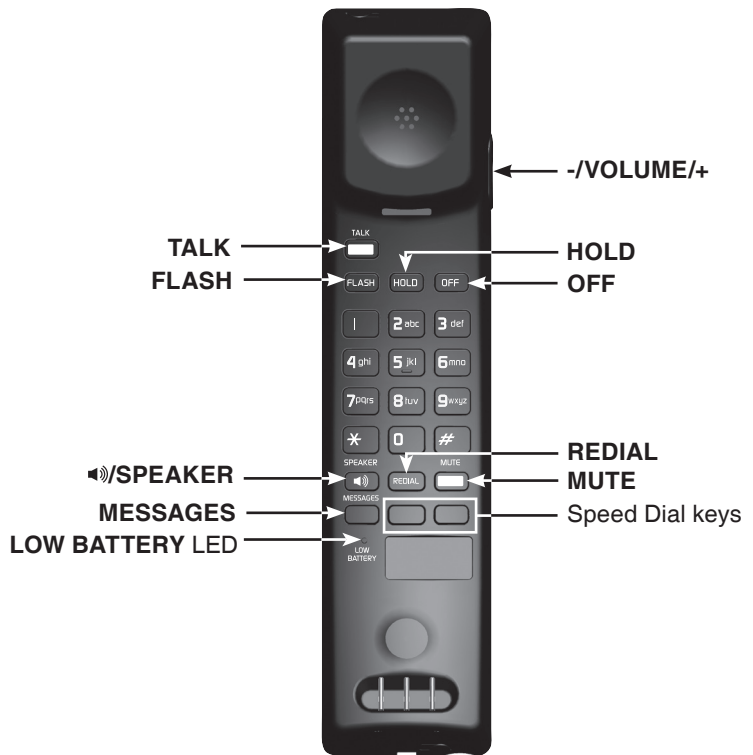
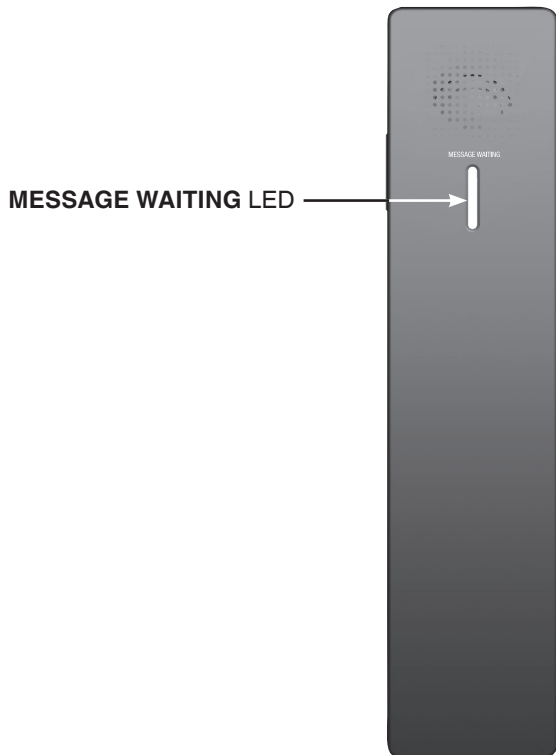
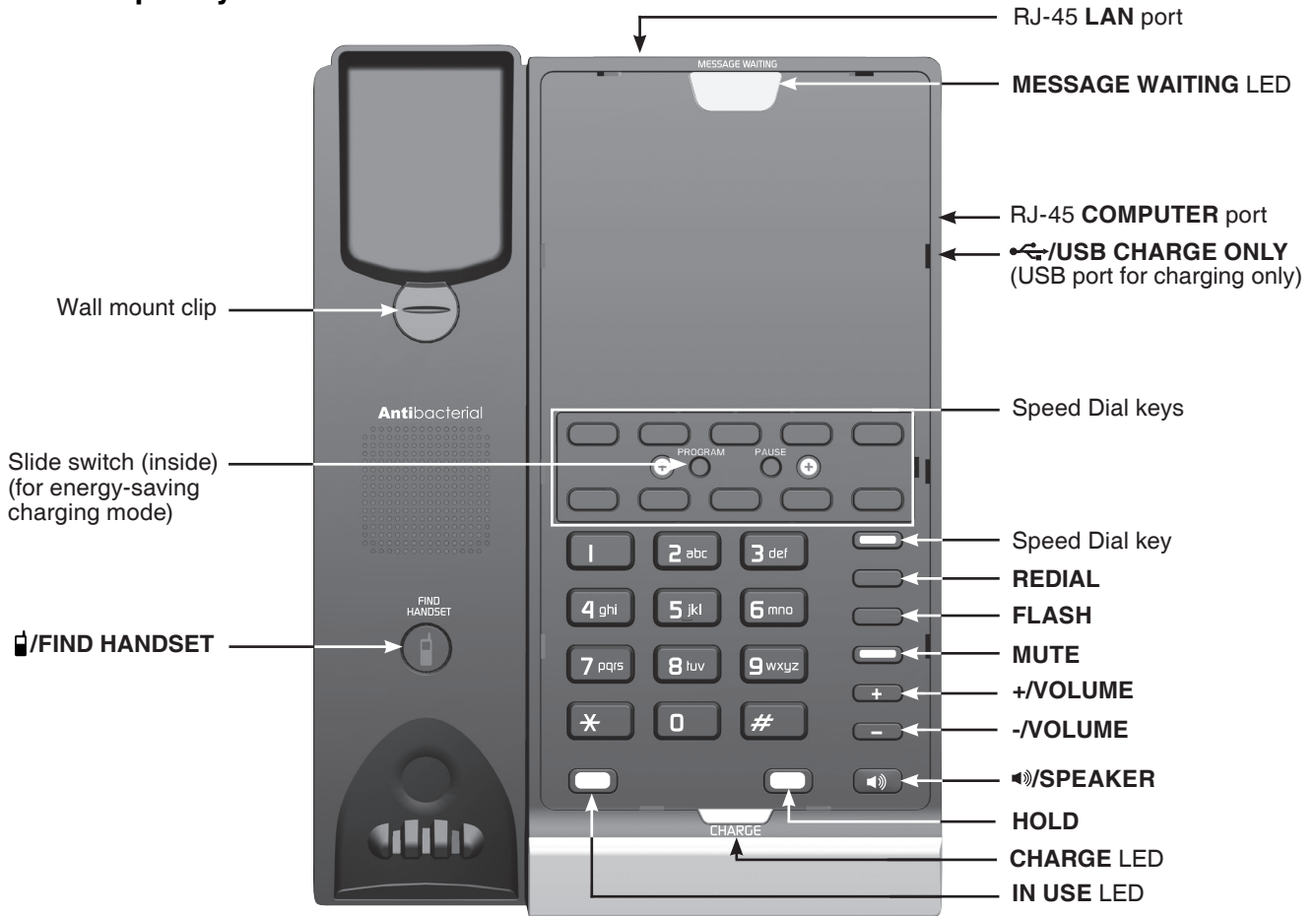

NOTE: Keep the slide switch (inside the phone) on the left side to maintain normal telephone operation.

Telephone layout

SIP contemporary cordless 1-line accessory Petite - CTM-S241P

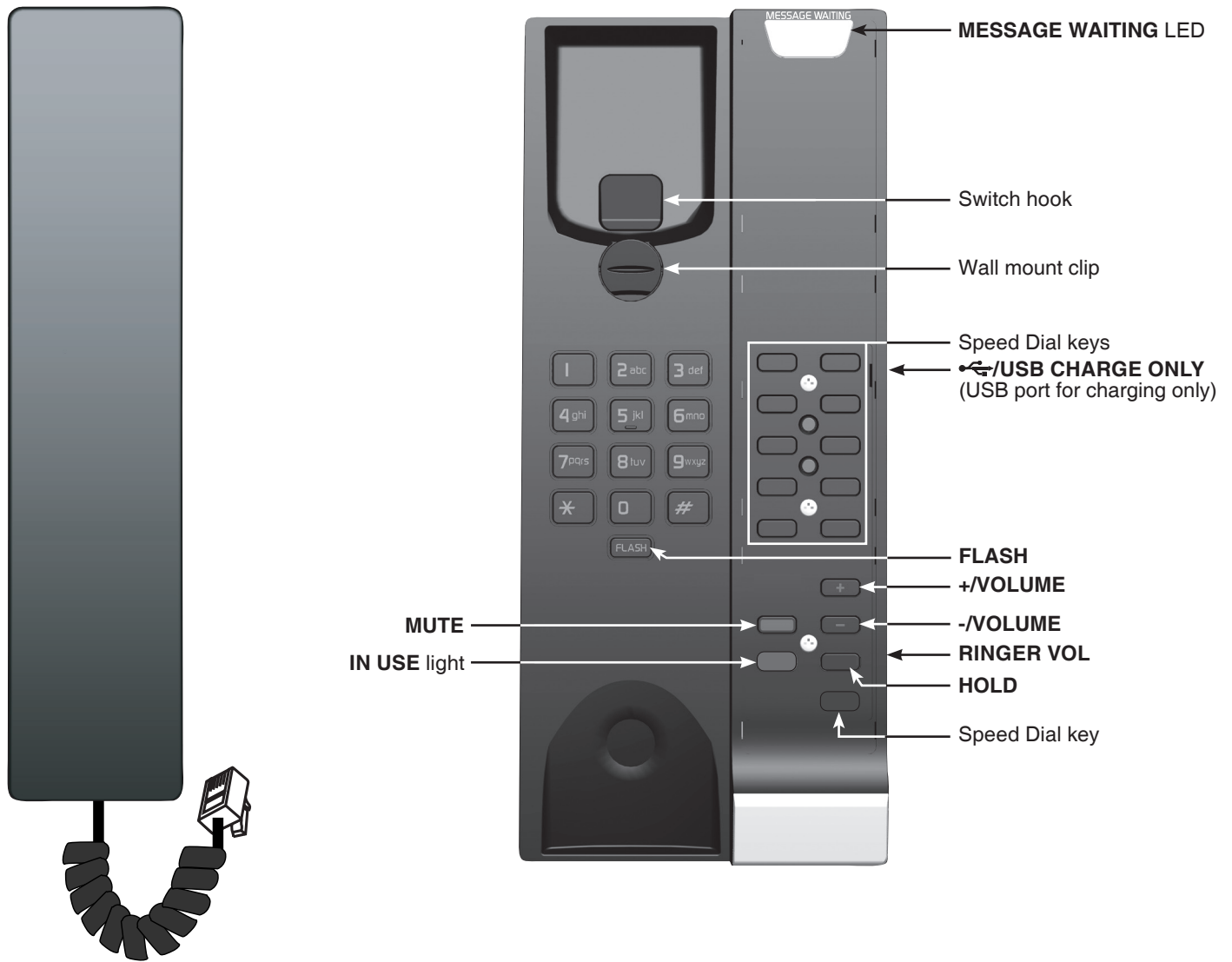

Telephone layout

Telephone layout

SIP contemporary cordless 2-line - S2420

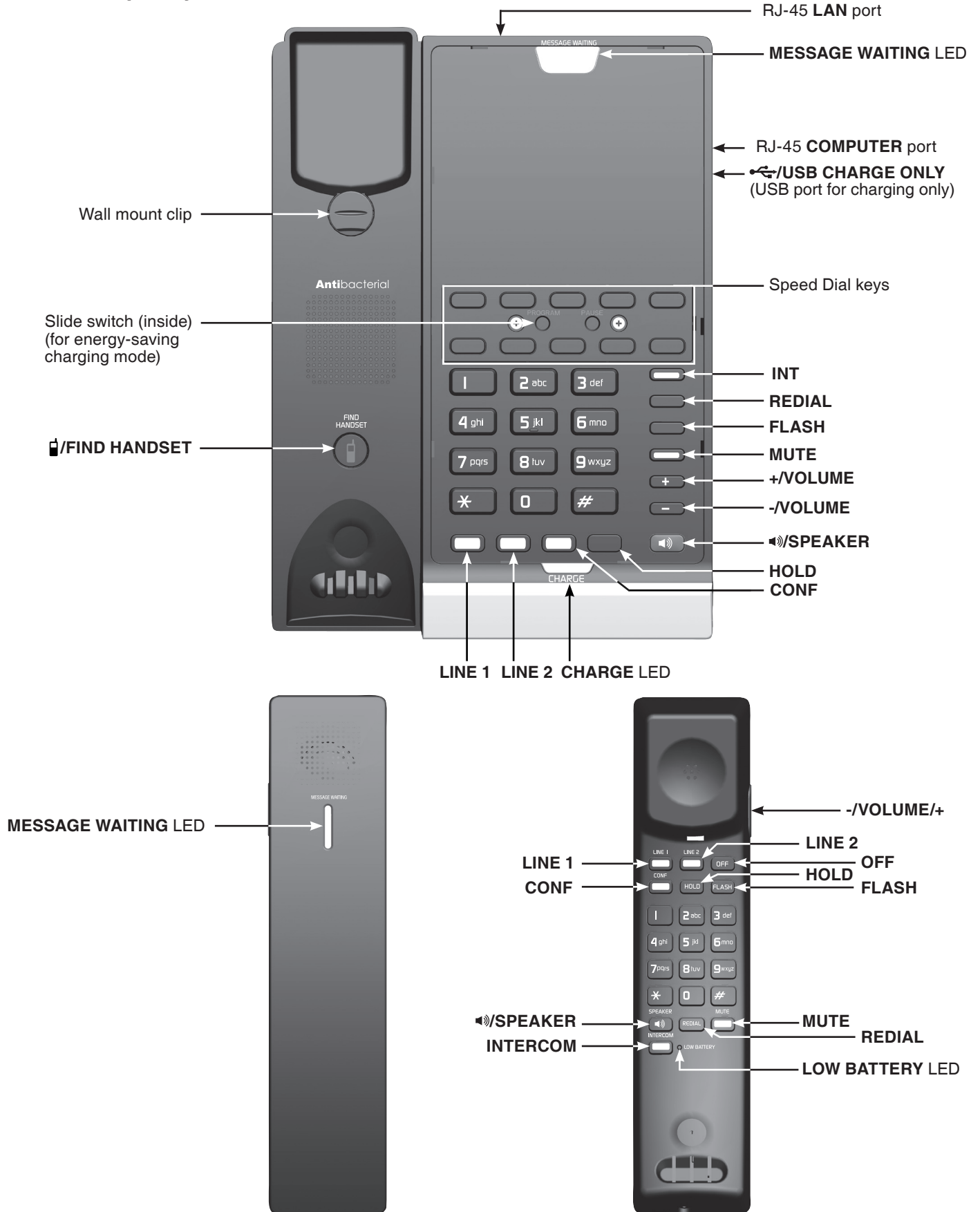

NOTE: Keep the slide switch (inside the phone) on the left side to maintain normal telephone operation.

Telephone layout

SIP contemporary cordless 2-line - CTM-S2421

Telephone layout

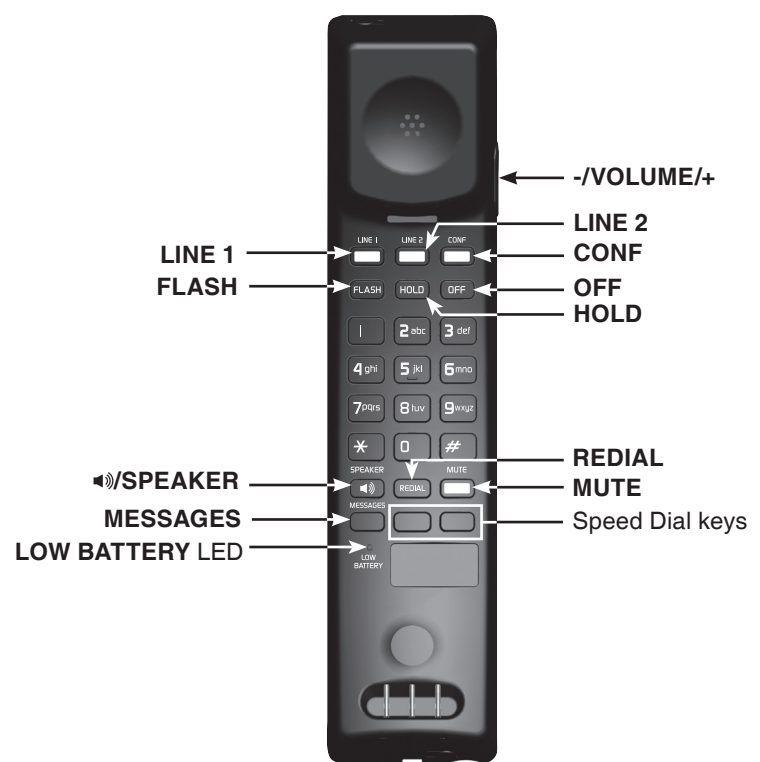
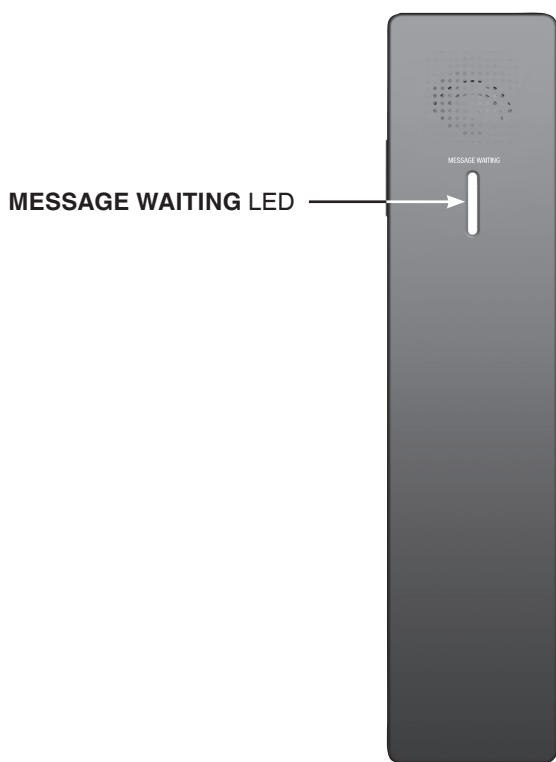
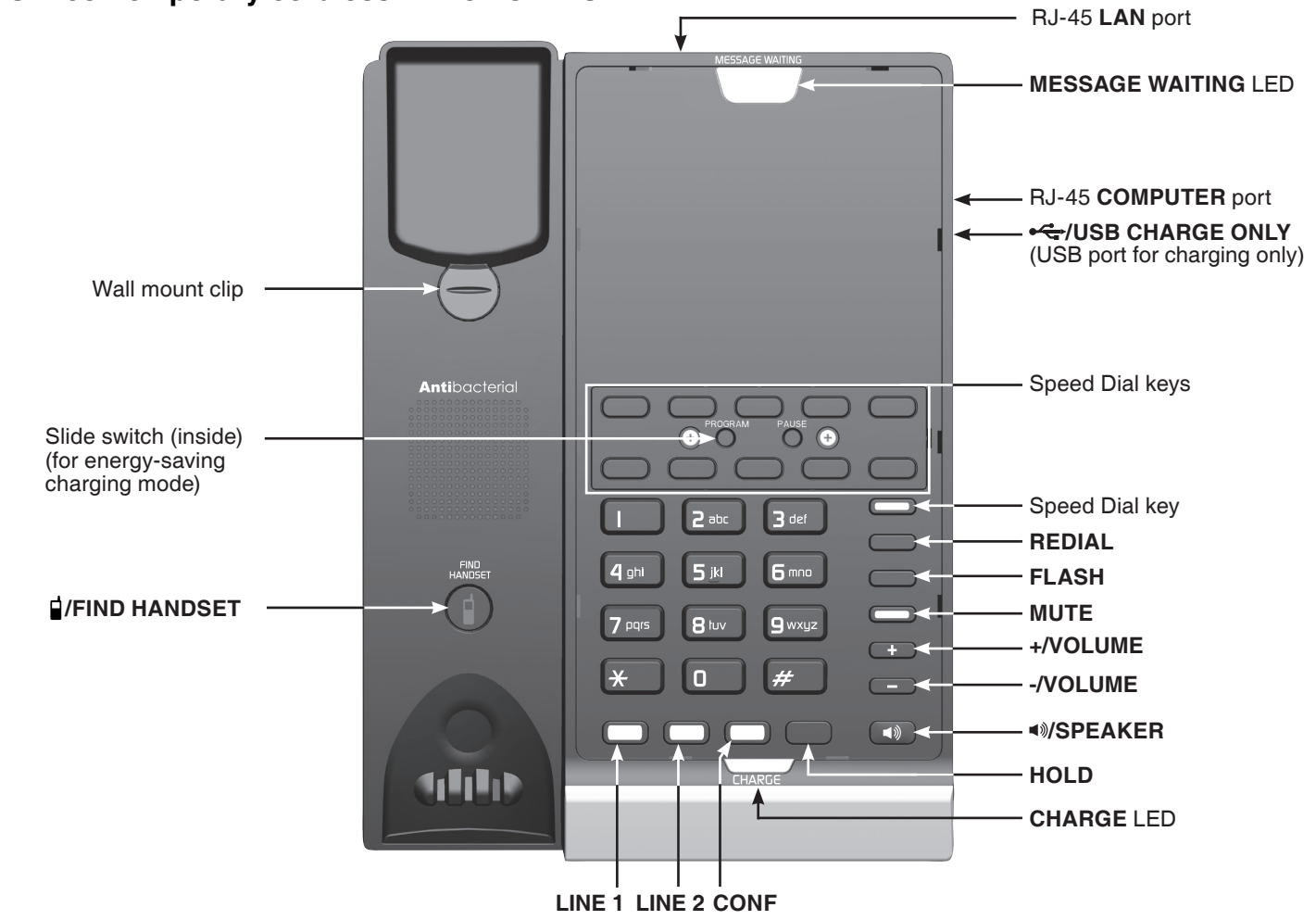

NOTE: Keep the slide switch (inside the phone) on the left side to maintain normal telephone operation.

Telephone layout

SIP contemporary cordless 2-line accessory Petite - CTM-S242P

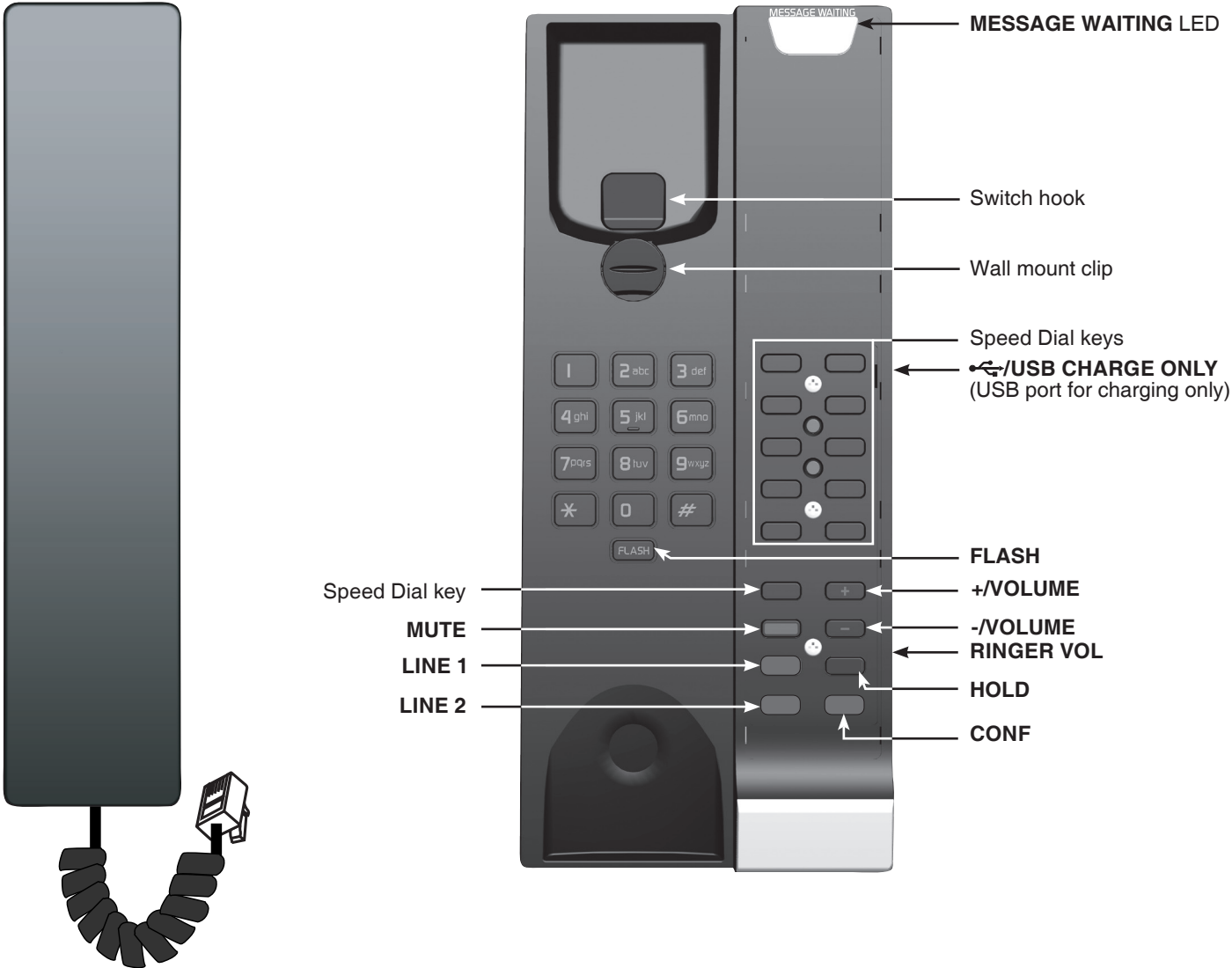

Telephone layout

SIP contemporary charging base - C4300

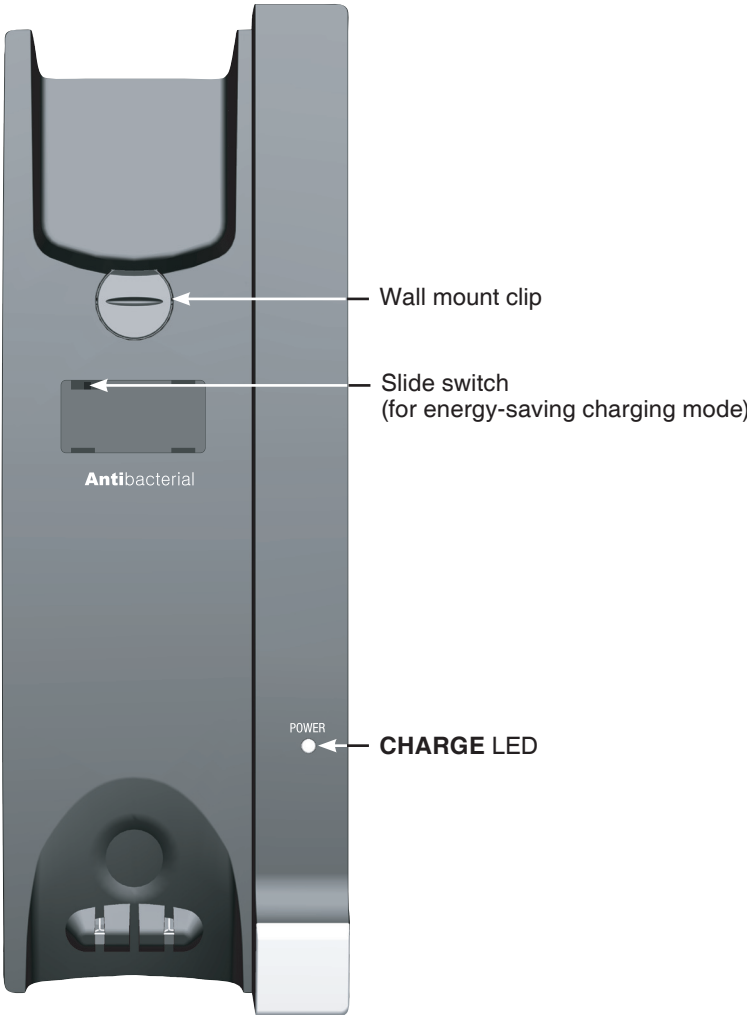

NOTE: Keep the slide switch on the left side to maintain normal telephone operation.

Telephone layout

SIP contemporary charging stand - C4310

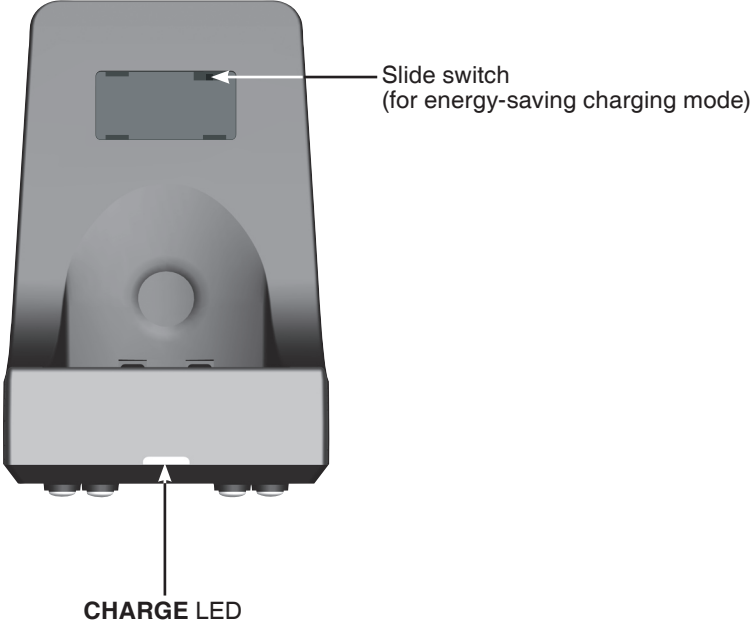

NOTE: Keep the slide switch on the left side to maintain normal telephone operation.

Telephone layout

SIP contemporary cordless 1-line accessory handset - C4400

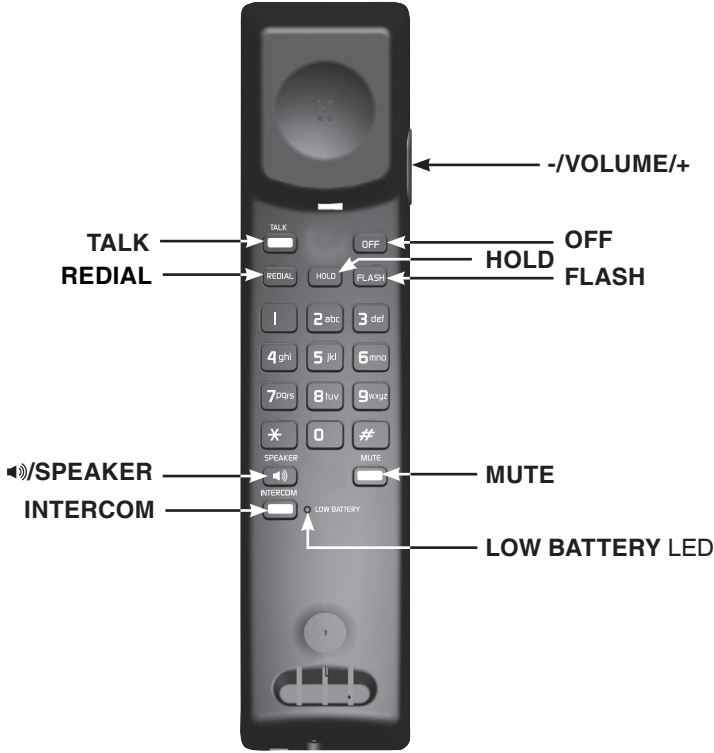
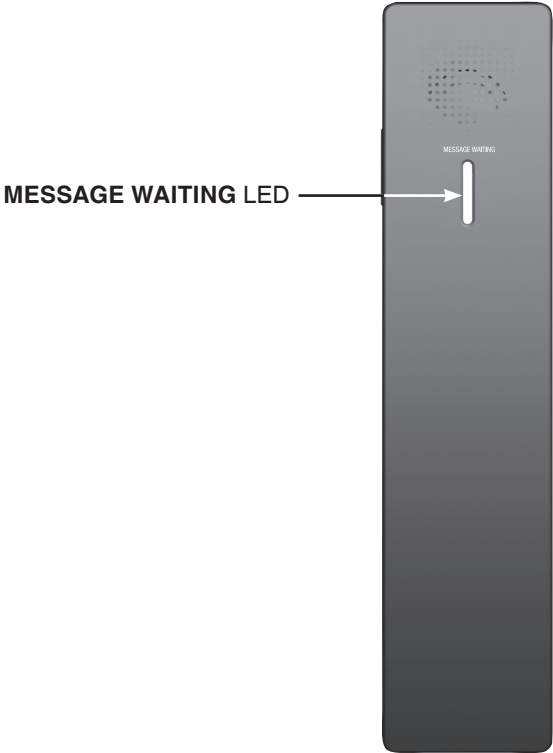

Telephone layout

SIP contemporary cordless 1-line accessory handset - CTM-C4401

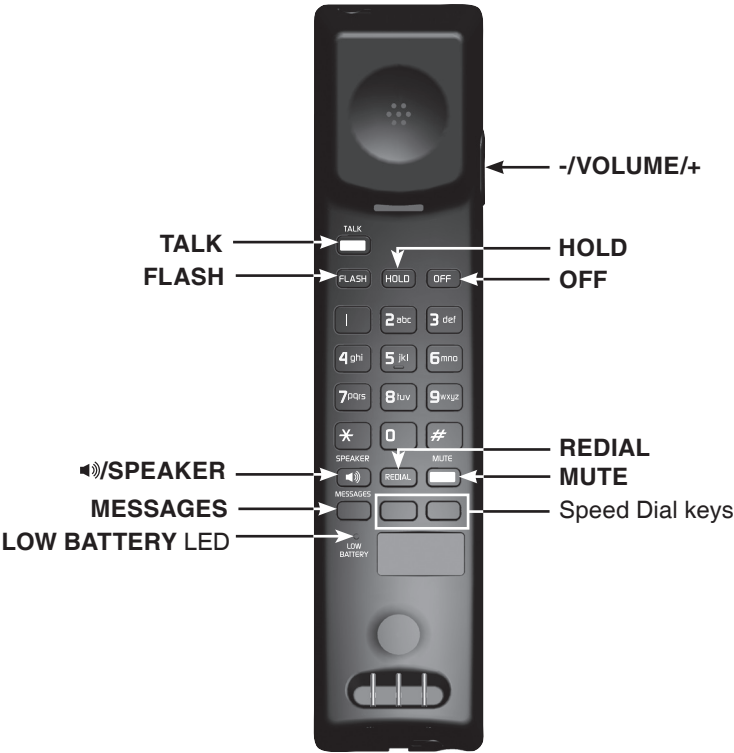
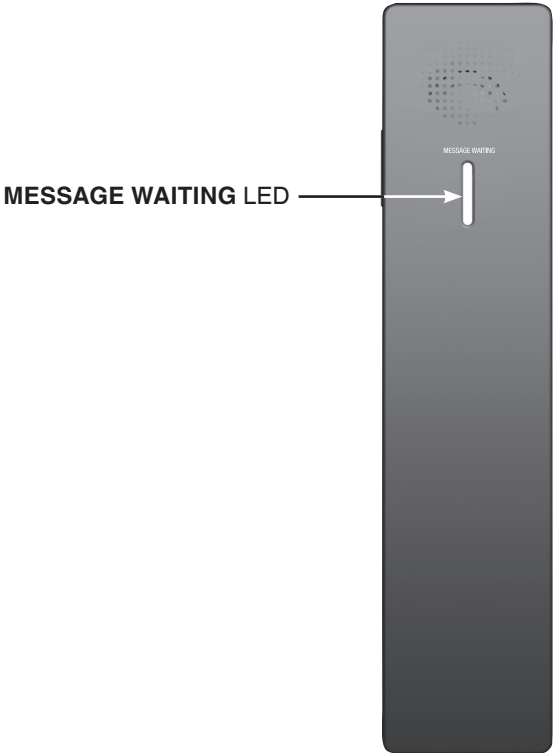

Telephone layout

SIP contemporary cordless 2-line accessory handset - C4500

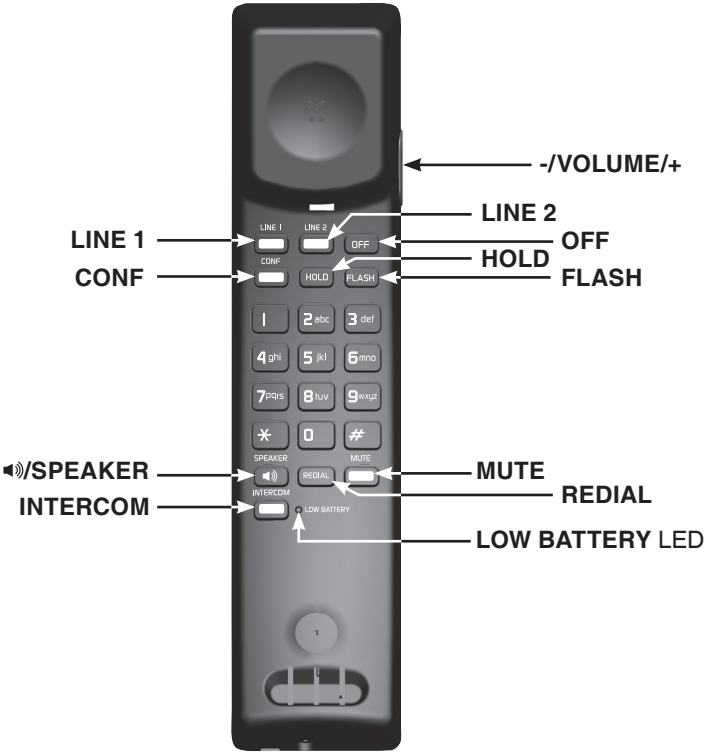
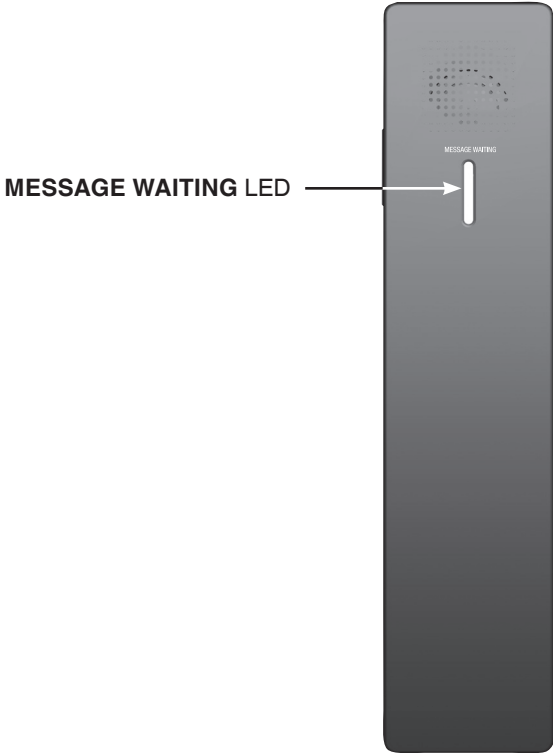

Telephone layout

Telephone layout

SIP contemporary cordless 2-line accessory handset - CTM-C4501

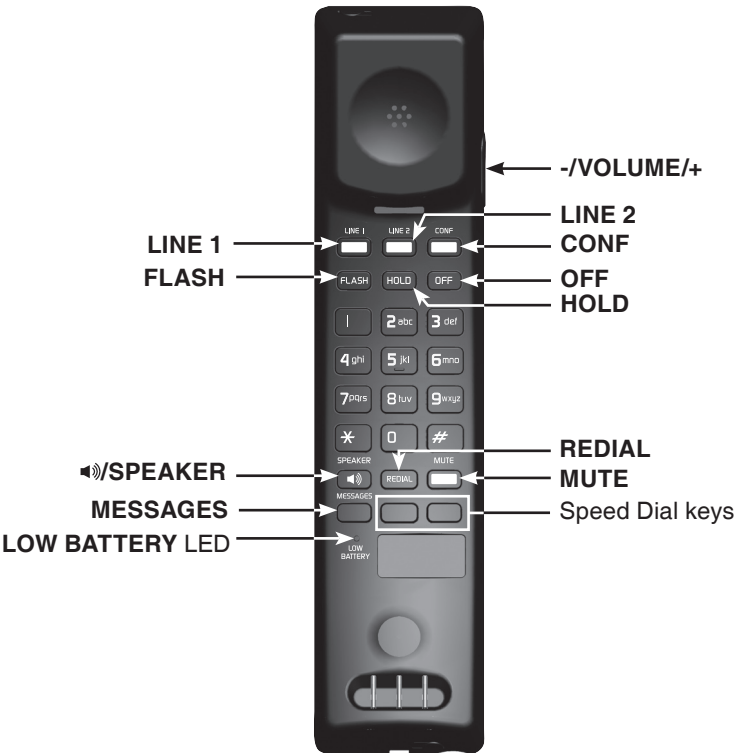
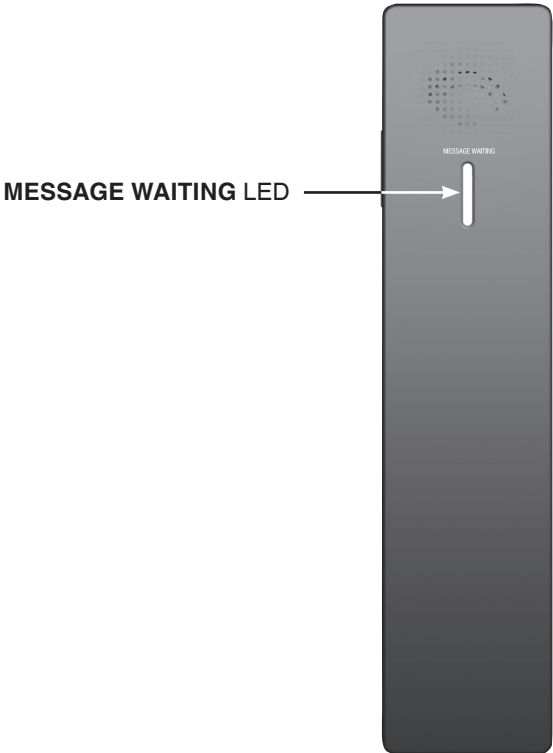

Telephone layout

SIP contemporary cordless 1-line accessory handset and charger bundle - CTM-S241HS

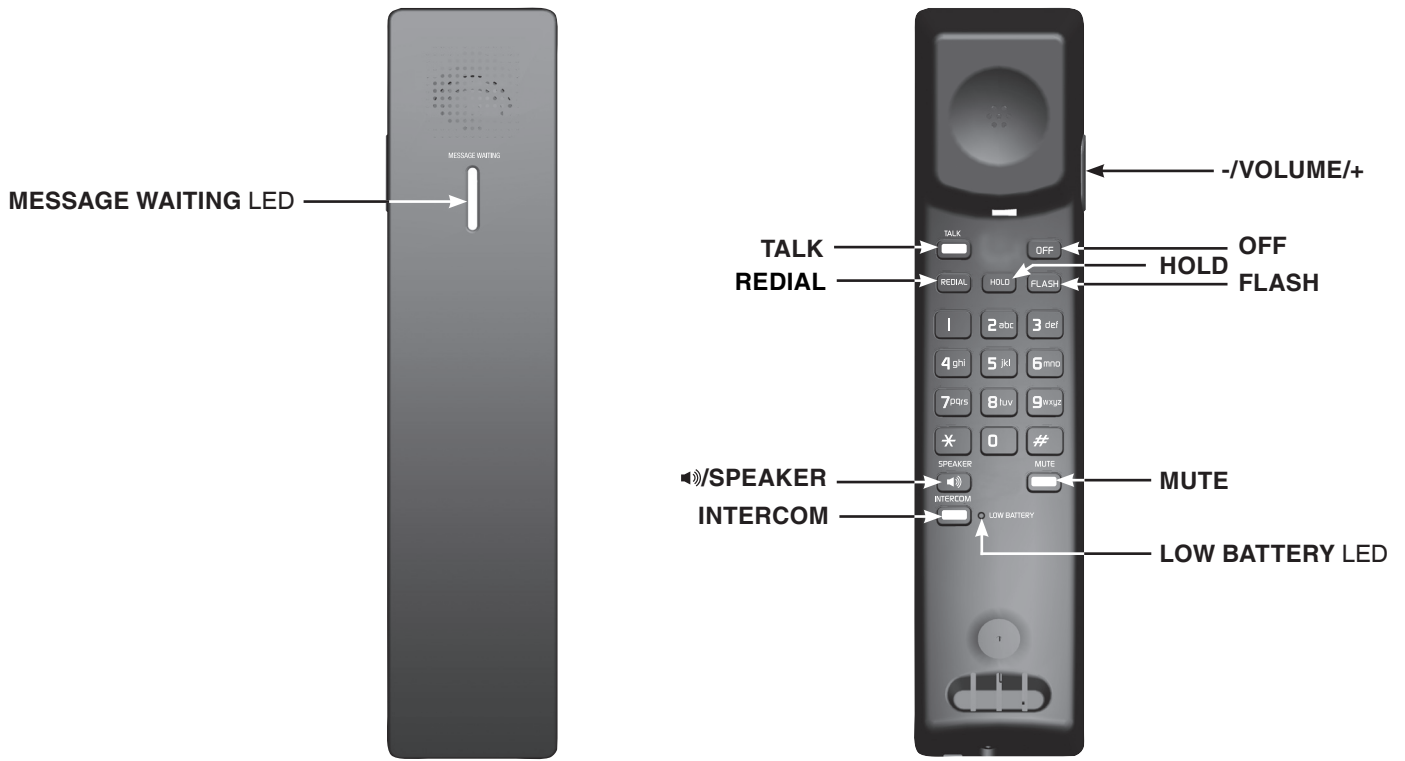

Telephone layout



Telephone layout

SIP contemporary cordless 2-line accessory handset and charger bundle - CTM-S242HS

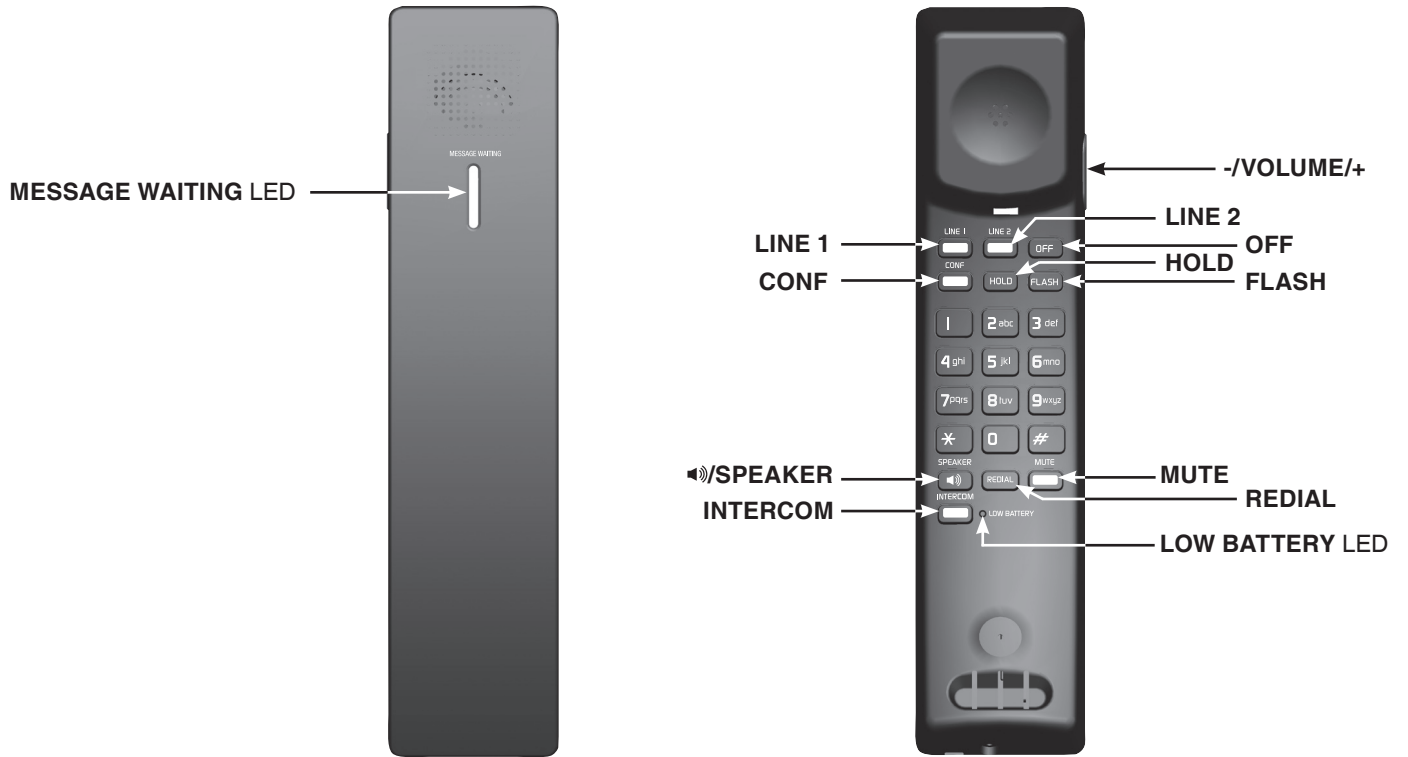

Telephone layout

SIP contemporary cordless 1-line accessory handset with speed dials and charger bundle
- CTM-S241SD

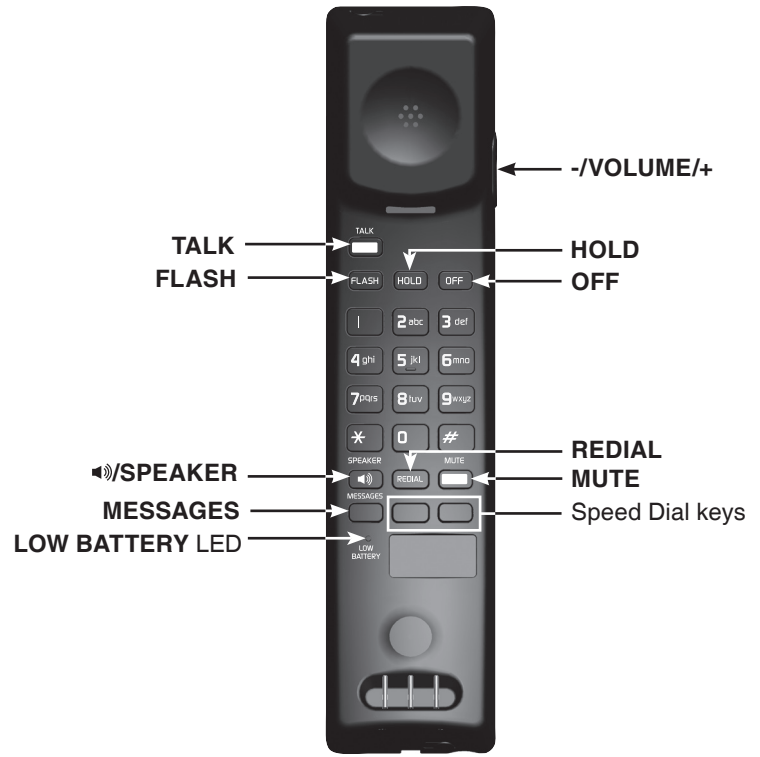
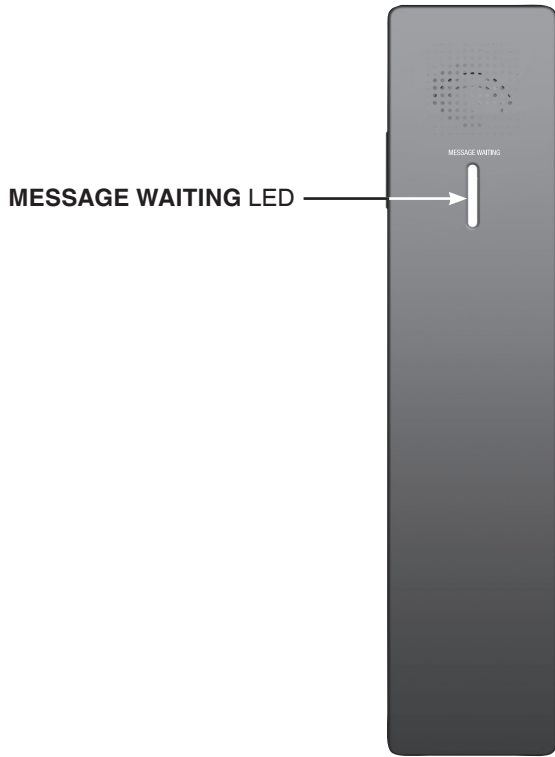

Telephone layout



Telephone layout

SIP contemporary cordless 2-line accessory handset with speed dials and charger bundle
- CTM-S242SD

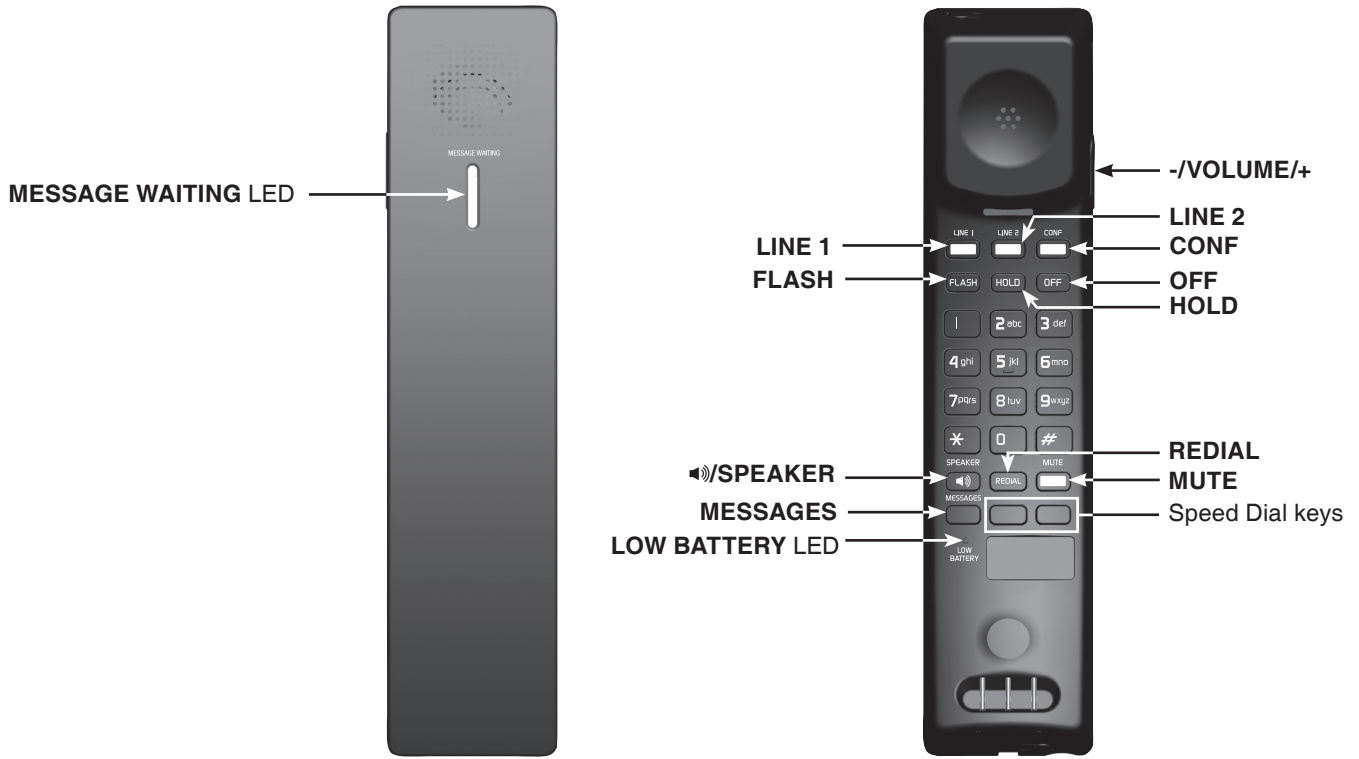

Installation

SIP classic trimstyle 1-line/2-line - S1310/S1320

Telephone base installation

The telephone base can be adapted to desktop use or mount on a standard telephone wall plate.

Installation option - desktop position

1. Turn the telephone base over with the bottom side facing up. Connect the Cat-5 network cable into the RJ-45 LAN port on the telephone base and route through the channel as shown below.

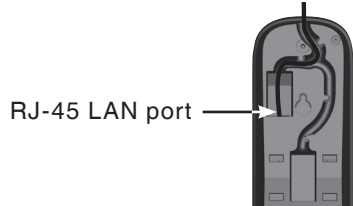

2. Insert the tabs of the mounting bracket into the upper grooves at the bottom of the telephone base as shown below. Then tighten the screw to affix the mounting bracket.

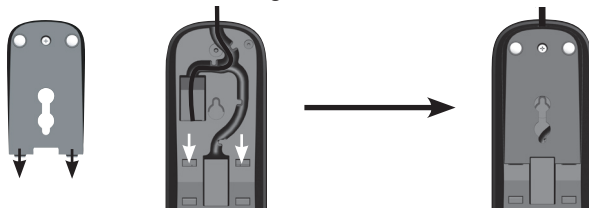

3. Plug the other end of the Cat-5 network cable into the network wall jack with Power over Ethernet (PoE). Then connect the coiled handset cord to the telephone base.

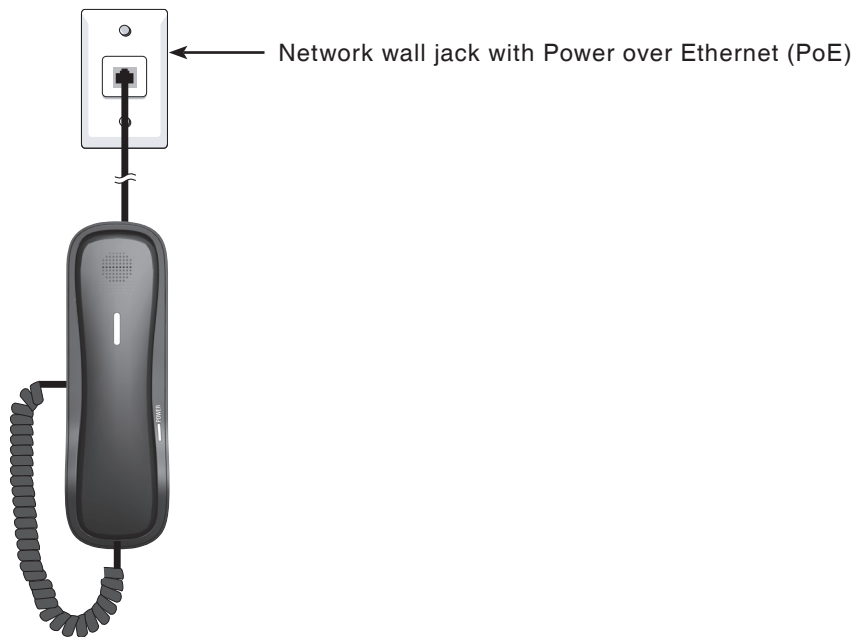

Installation

Installation

SIP classic trimstyle 1-line/2-line - S1310/S1320

Installation option - converting from desktop to wall mount position

1. Unplug the Cat-5 network cable from the network wall jack.
2. Put the handset aside. On the telephone base, place a coin in the slit of the wall mount clip and rotate a half turn (180 degrees). It locks into place with the protruding edge pointing towards the upper edge of the telephone base. This protruding edge holds the cordless handset when the phone is mounted on the wall.

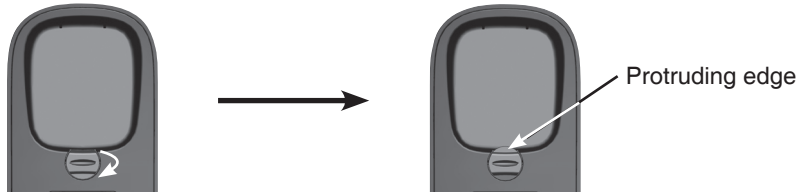

3. Loosen the screw from the mounting bracket and remove the mounting bracket from the upper grooves of the telephone base.

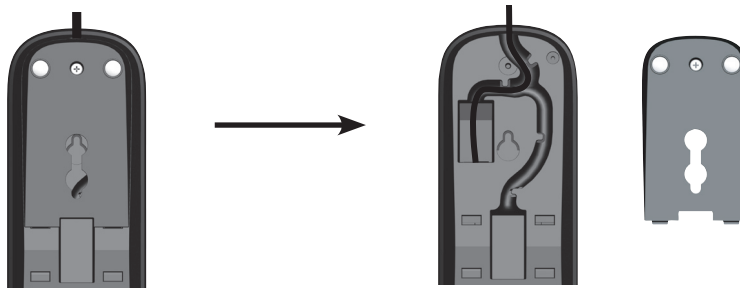

4. Rotate the mounting bracket. Insert the tabs of the mounting bracket into the lower grooves of the telephone base. Then tighten the screw to affix the mounting bracket.

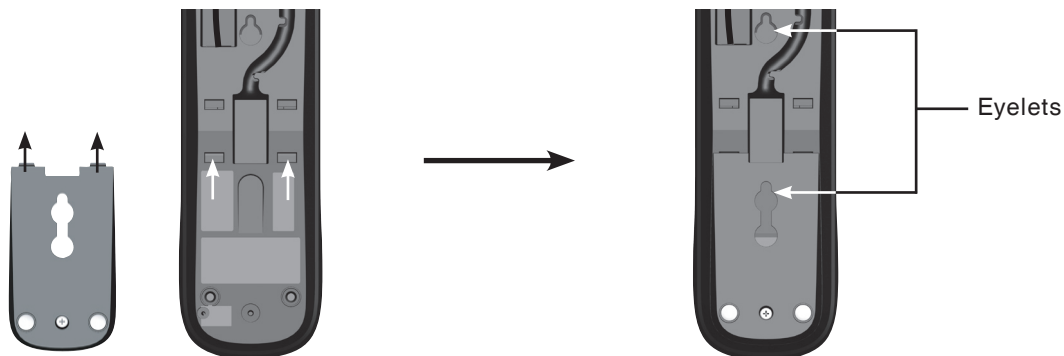

5. Mount the telephone base on the wall by aligning the eyelets with the mounting studs of the wall plate. Then slide the it down on both mounting studs until it locks into place.
6. Plug the Cat-5 network cable back to the network wall jack with Power over Ethernet (PoE). Then replace the handset on the telephone base cradle.

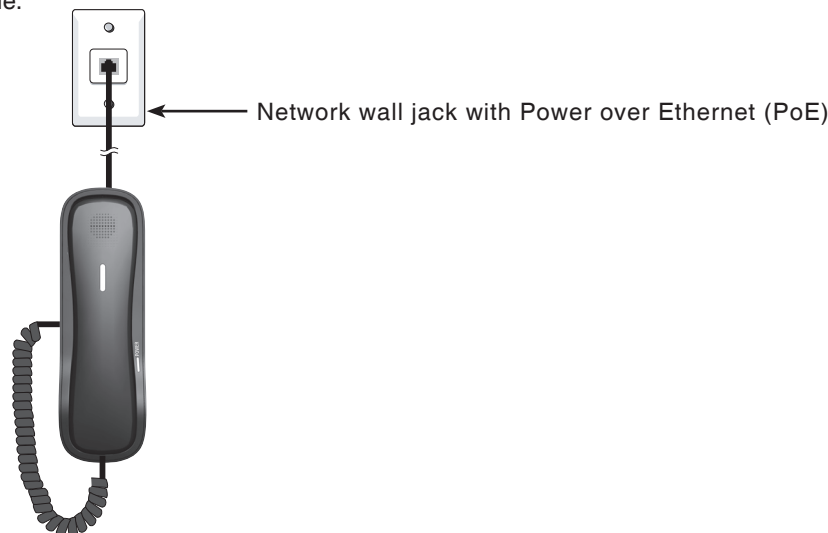

NOTE: FCC ID is shown on the back of the corded handset body after the handset cover is removed.

Installation

SIP classic trimstyle 1-line/2-line - S1310/S1320

Handset registration

An **S1310/S1320** handset must be registered to an **S1410/S1420** telephone base before use.

To register an S1310 handset:

Place the corded handset on the **S1410** telephone base cradle. Handset registration happens automatically the first time a handset is placed on the **S1410**. When the registration process completes, the **MESSAGE WAITING** LED flashes once and you hear 3 rising beeps as confirmation. Each **S1410** accommodates up to 4 handsets. When you already have 4 registered handsets, you can replace one of them by a new handset if any one of the 4 registered handsets is disconnected from the **S1410**. For example, it is out of range, or its battery is removed or depleted. The previous registered handset is then deregistered from the **S1410**.

To register an S1320 handset:

Place the corded handset on the **S1420** telephone base cradle. Handset registration happens automatically the first time a handset is placed on the **S1420**. When the registration process completes, the **MESSAGE WAITING** LED flashes once and you hear 3 rising beeps as confirmation. Each **S1420** accommodates up to 4 handsets. When you already have 4 registered handsets, you can replace one of them by a new handset if any one of the 4 registered handsets is disconnected from the **S1420**. For example, it is out of range, or its battery is removed or depleted. The previous registered handset is then deregistered from the **S1420**.

Register a handset to another telephone base

Any classic trimstyle 1-line handset can register to any classic cordless 1-line telephone base. Any classic trimstyle 2-line handset can register to any classic cordless 2-line telephone base.

When a registered handset is idle, place it on another telephone base. This handset automatically registers to the new telephone base.

Installation

SIP classic cordless 1-line/2-line - S1410/S1420

Telephone base installation

1. The telephone comes ready for desktop use. Install the telephone base as shown below.

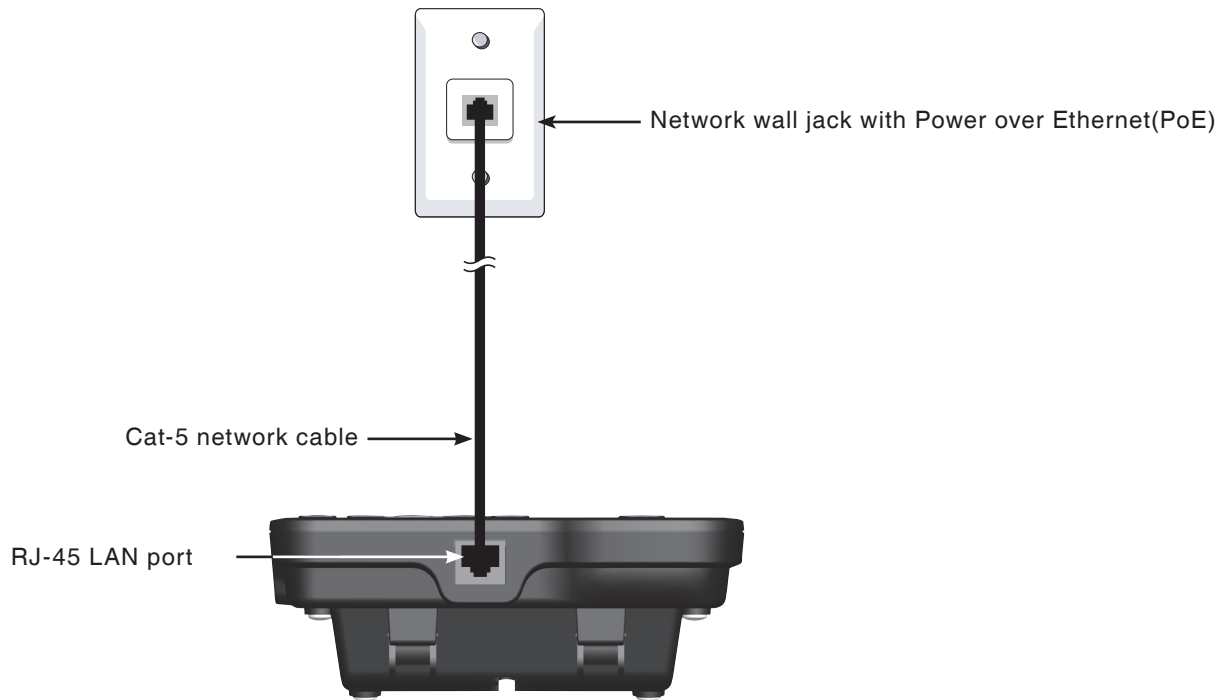

2. Once installed, the telephone begins a four-step initialization and system registration process.

- For **S1410**: (1) The **MUTE** key and the **🔊/SPEAKER** key turn on and then go off. (2) The **MUTE** key flashes. (3) The **MUTE** key stops flashing and then the **🔊/SPEAKER** key flashes. (4) The **MESSAGE WAITING LED, LINE, MUTE** and **🔊/SPEAKER** illuminate for 500ms when initialization and system registration are successful.
- For **S1420**: (1) The **MUTE** key and the **🔊/SPEAKER** key turn on and then go off. (2) The **MUTE** key flashes. (3) The **MUTE** key stops flashing and then **🔊/SPEAKER** key flashes. (4) The **MESSAGE WAITING LED, LINE 1, LINE 2, CONF, MUTE** and **🔊/SPEAKER** illuminate for 500ms when initialization and system registration are successful.

If the system registration fails, the **🔊/SPEAKER** key blinks twice every second. To reset, disconnect the Cat-5 network cable from the network wall jack with Power over Ethernet (PoE) and then reconnect.

CAUTION:

Use only the supplied Cat-5 network cable. Cat-5 network cable is not designed for use in any other IT devices. Misuse of Cat-5 network cable on your other IT devices shall be prohibited. To order a replacement, call 1-888-907-2007.

Installation

SIP classic cordless 1-line/2-line - S1410/S1420

Handset battery installation

Install the battery as shown below.

1. Gently lift the handset cover. Do not detach the speaker wires between the handset cover and the handset.
2. Plug the battery connector securely into the socket inside the handset battery compartment.
3. Place the battery with the label **THIS SIDE UP** facing up and the wires inside the battery compartment.
4. To replace the handset cover, align all the tabs on the handset cover against the corresponding grooves on the handset, then firmly push downward until all the tabs lock in the grooves. Then install the screw at the bottom of the handset.



Replace a handset battery

1. Use a narrow object to open the screw cover and then remove the screw. Insert a 5 mm standard screwdriver in the provided slot, then twist and lift to remove the handset cover. Do not detach the speaker wires between the handset cover and the handset.

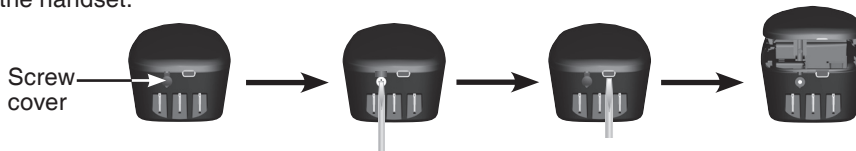

2. Unplug the battery connector from the socket and then remove the battery from the handset battery compartment.
3. Follow Step 2 to Step 4 in **Handset battery installation** above to install a new battery.

CAUTIONS:

- There may be a risk of explosion if a wrong type of handset battery is used. Use only the supplied rechargeable battery (BT264392/BT266342) or replacement battery (BT266342). To order a replacement, call 1-888-907-2007.
- FCC ID is shown on the back of the cordless handset body after the handset cover is removed.
- Dispose of used batteries according to the information in **The RBRC® seal** on page 81.

Handset registration

Place the cordless handset on the telephone base cradle. Handset registration happens automatically the first time a cordless handset is placed on the telephone base. When the registration process completes, the **MESSAGE WAITING** LED flashes once and you hear 3 rising beeps as confirmation. Each telephone base accommodates up to 4 cordless handsets. When you already have 4 registered handsets, you can replace one of them by a new handset if any one of the 4 registered handsets is disconnected from the base. For example, it is out of range, or its battery is removed or depleted. The previous registered handset is then deregistered from the telephone base.

Register a handset to another telephone base

Any classic cordless 1-line handset can register to any classic cordless 1-line telephone base. Any classic cordless 2-line handset can register to any classic cordless 2-line telephone base.

When a registered cordless handset is idle, place it on another telephone base. This cordless handset automatically registers to the new telephone base.

Handset battery charging

The battery must be fully charged before using the cordless handset for the first time. The **CHARGE** LED turns on when the cordless handset is charging on the telephone base or charging base. The battery is fully charged after 16 hours of continuous charging. For best performance, keep the cordless handset in the telephone base or charging base when not in use.

Installation

SIP classic cordless 1-line/2-line - S1410/S1420

Installation option - converting from desktop to wall mount position

This telephone can be adapted to desktop use or mount on a standard telephone wall plate.

To mount the telephone base on the wall:

1. Unplug the Cat-5 network cable from the network wall jack.
2. Remove the cordless handset from the telephone base cradle. On the telephone base, place a coin in the slit of the wall mount clip and rotate a half turn (180 degrees). It locks into place with the protruding edge pointing towards the upper edge of the telephone base. This protruding edge holds the cordless handset when the phone is mounted on the wall.

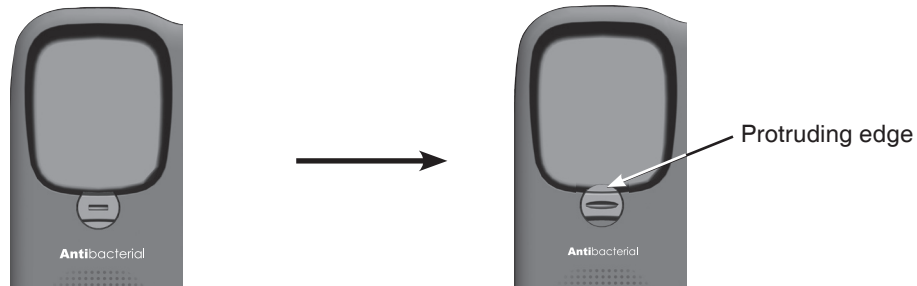

3. Turn the telephone base over with the bottom side facing up. To remove the mounting bracket, press the tabs of the mounting bracket in the direction indicated below to release and remove it from the telephone base.

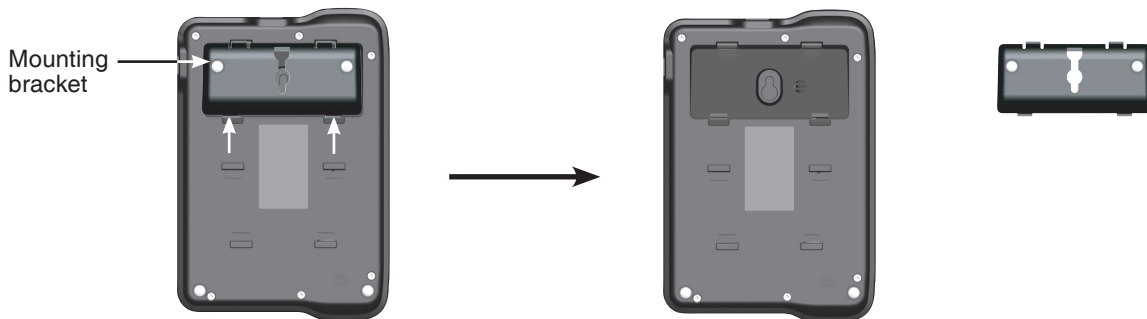

4. Rotate the mounting bracket. Insert the tabs of the mounting bracket into the middle grooves on the telephone base as shown below. Then press the tabs and push the mounting bracket into the lower grooves on the telephone base until they lock securely.

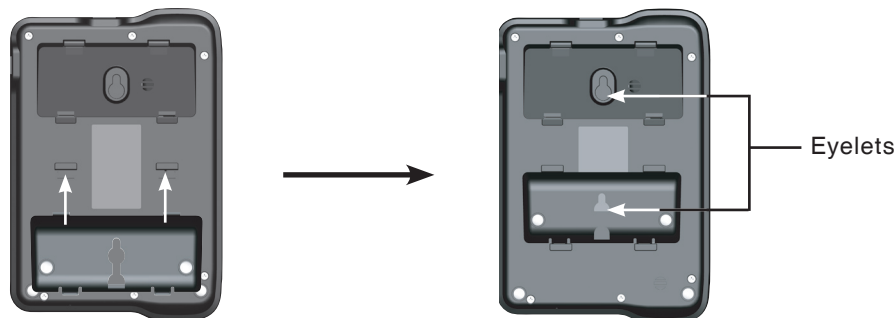

5. Mount the telephone base on the wall by aligning the eyelets with the mounting studs of the wall plate. Then slide the telephone base down on both mounting studs until it locks into place.
6. Plug the Cat-5 network cable back in the network wall jack with Power over Ethernet (PoE). Then place the cordless handset on the telephone base cradle.

Installation

SIP classic charging base - C3300

Charging base installation

The charging base can be adapted to desktop use or mount on a standard telephone wall plate.

Installation option - desktop position

1. Turn the charging base over with the bottom side facing up. Connect the Cat-5 network cable into the RJ-45 LAN port on the charging base.

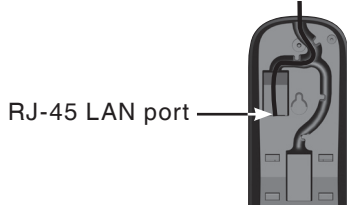

2. Insert the tabs of the mounting bracket into the upper grooves at the bottom of the charging base as shown below. Then tighten the screw to affix the mounting bracket.

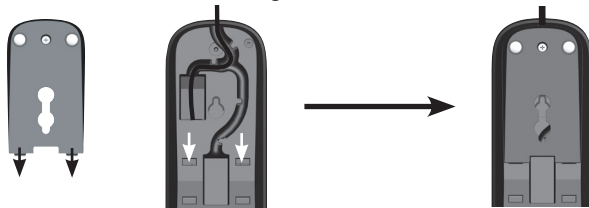

3. Plug the other end of the Cat-5 network cable into the network wall jack with Power over Ethernet (PoE).

Installation option - converting from desktop to wall mount position

1. Unplug the Cat-5 network cable from the network wall jack.
2. Remove the cordless handset from the charging base cradle. On the charging base, place a coin in the slit of the wall mount clip and rotate a half turn (180 degrees). It locks into place with the protruding edge pointing towards the upper edge of the charging base. This protruding edge holds the cordless handset when the phone is mounted on the wall.

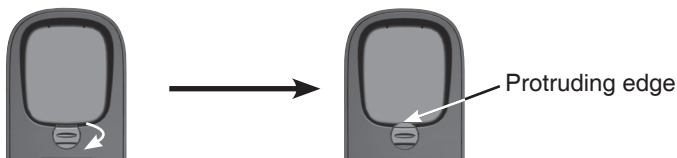

3. Loosen the screw from the mounting bracket and remove the mounting bracket from the grooves of the charging base.

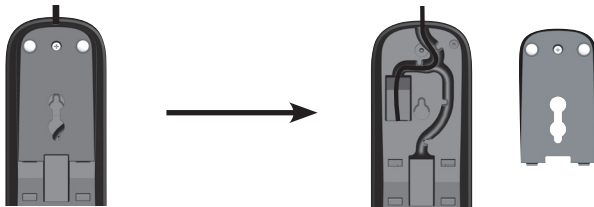

4. Rotate the mounting bracket. Insert the tabs of the mounting bracket into the lower grooves of the charging base. Then tighten the screw to affix the mounting bracket.

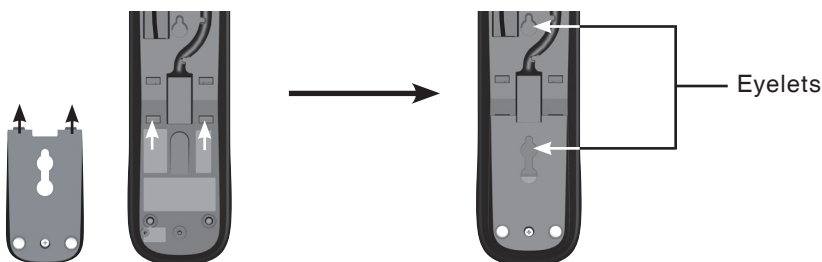

5. Mount the charging base on the wall by aligning the eyelets with the mounting studs of the wall plate. Then slide it down on both mounting studs until it locks into place.
6. Plug the Cat-5 network cable back into the network wall jack with Power over Ethernet (PoE).

Installation

SIP classic cordless 1-line/2-line accessory handset - C3400/C3500

Handset battery installation

Install the battery as shown below.

1. Gently lift the handset cover. Do not detach the speaker wires between the handset cover and the handset.
2. Plug the battery connector securely into the socket inside the handset battery compartment.
3. Place the battery with the label **THIS SIDE UP** facing up and the wires inside the battery compartment.
4. To replace the handset cover, align all the tabs on the handset cover against the corresponding grooves on the handset, then firmly push downward until all the tabs lock in the grooves. Then install the screw at the bottom of the handset.



Replace a handset battery

1. Use a narrow object to pry open the screw cover and remove the screw. Insert a 5 mm standard screwdriver in the provided slot, then twist and lift to remove the handset cover. Do not detach the speaker wires between the handset cover and the handset.

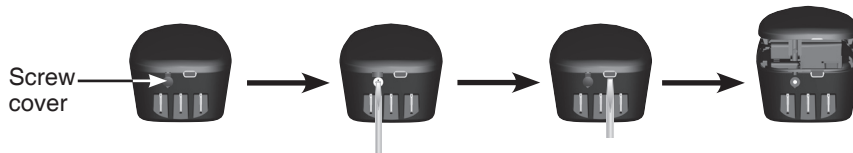

2. Unplug the battery connector from the socket and then remove the battery from the handset battery compartment.
3. Follow the Step 2 to Step 4 in **Handset battery installation** above to install a new battery.

CAUTIONS:

- There may be a risk of explosion if a wrong type of handset battery is used. Use only the supplied rechargeable battery (BT264392/BT266342) or replacement battery (BT266342). To order a replacement, call 1-888-907-2007.
- FCC ID is shown on the back of the cordless handset body after the handset cover is removed.
- Dispose of used batteries according to the information in **The RBRC® seal** on page 81.

Handset registration

Place the cordless handset on the telephone base cradle. Handset registration happens automatically the first time a cordless handset is placed on the telephone base. When the registration process completes, the **MESSAGE WAITING LED** flashes once and you hear 3 rising beeps as confirmation. Each telephone base accommodates up to 4 cordless handsets. When you already have 4 registered handsets, you can replace one of them by a new handset if any one of the 4 registered handsets is disconnected from the base. For example, it is out of range, or its battery is removed or depleted. The previous registered handset is then deregistered from the telephone base.

Register a handset to another telephone base

Any classic cordless 1-line handset can register to any classic cordless 1-line telephone base. Any classic cordless 2-line handset can register to any classic cordless 2-line telephone base.

When a registered cordless handset is idle, place it on another telephone base. This cordless handset automatically registers to the new telephone base.

Handset battery charging

The battery must be fully charged before using the cordless handset for the first time. The **CHARGE LED** turns on when the cordless handset is charging on the telephone base or charging base. The battery is fully charged after 16 hours of continuous charging. For best performance, keep the cordless handset in the telephone base or charging base when not in use.

Installation

SIP contemporary trimstyle 1-line/2-line - S2310/S2320

Telephone base installation

The telephone can be adapted to desktop use or mount on a standard telephone wall plate.

Installation option - desktop position

1. Turn the telephone base over with the bottom side facing up. Connect the Cat-5 network cable into the RJ-45 LAN port on the telephone base and route the cord out from the top eyelet on the mounting bracket, then position the mounting bracket as shown.

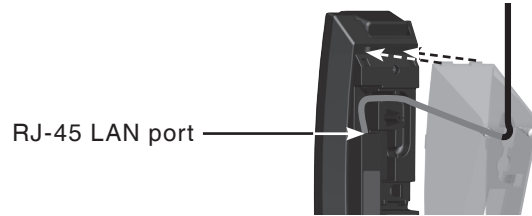

2. Insert the tabs into the upper grooves and tighten the screw to affix the mounting bracket in place.

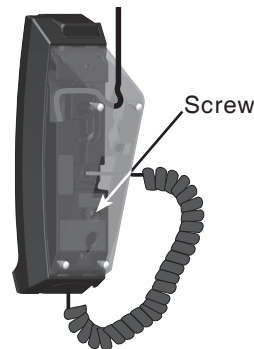

3. Plug the Cat-5 network cable into the network wall jack with Power over Ethernet (PoE). Then connect the coiled handset cord to the telephone base.

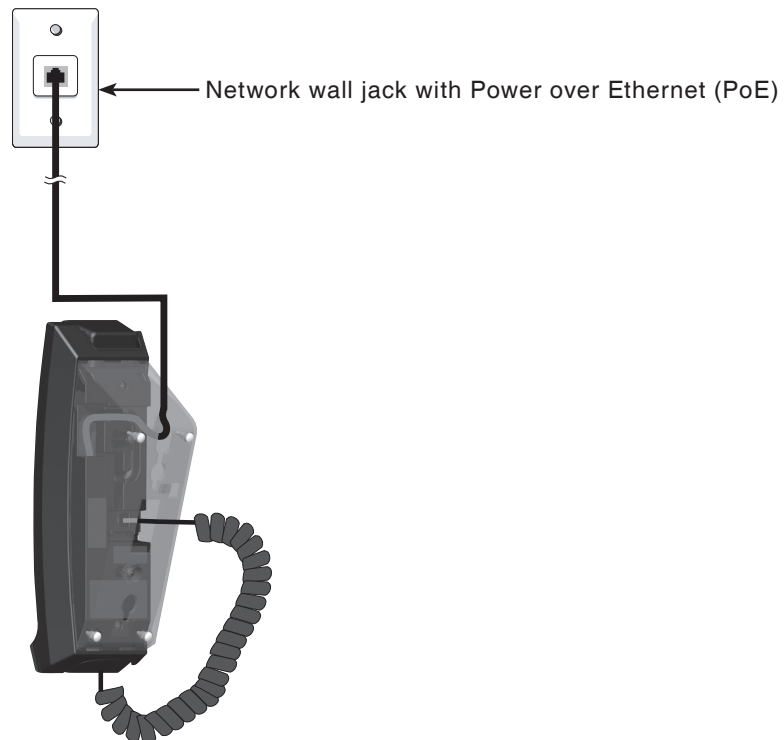

CAUTION:

Use only the supplied Cat-5 network cable. Cat-5 network cable is not designed for use in any other IT devices. Misuse of Cat-5 network cable on your other IT devices shall be prohibited. To order a replacement, call 1-888-907-2007.

Installation

SIP contemporary trimstyle 1-line/2-line - S2310/S2320

Installation option - converting from desktop to wall mount position

1. Unplug the Cat-5 network cable from the network wall jack.
2. Put the corded handset aside. On the telephone base, place a coin in the slit of the wall mount clip and rotate a half turn (180 degrees). It locks into place with the protruding edge pointing towards the upper edge of the telephone base. This protruding edge holds the cordless handset when the phone is mounted on the wall.

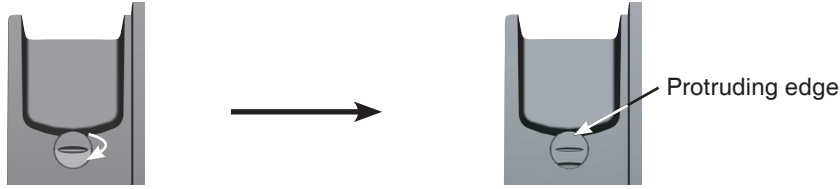

3. Loosen the screw from the mounting bracket and remove the mounting bracket from the grooves of the telephone base.

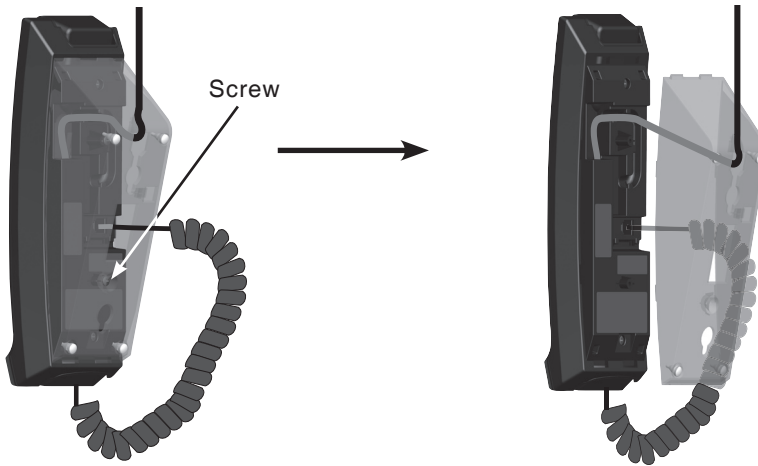

4. Rotate the mounting bracket. Insert the tabs of the mounting bracket into the lower grooves of telephone base. Then tighten the screw to affix the mounting bracket.

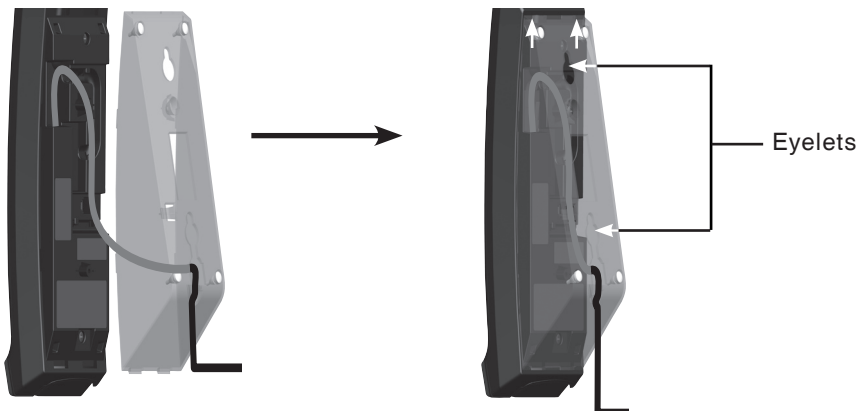

5. Mount the telephone base on the wall by aligning the eyelets with the mounting studs of the wall plate. Then slide the telephone base down on both mounting studs until it locks into place.
6. Plug the Cat-5 network cable back into the network wall jack with Power over Ethernet (PoE). Then replace the handset on the telephone base cradle.

NOTE: FCC ID is shown on the back of the corded handset body after the handset cover is removed.

Installation

SIP contemporary trimstyle 1-line/2-line - S2310-6VDC/S2320-6VDC

Telephone base installation

The telephone can be adapted to desktop use or mount on a standard telephone wall plate.

Installation option - desktop position

1. Turn the telephone base over with the bottom side facing up. Route the small end of the power adapter cord out from the top eyelet on the mounting bracket. Then connect it into the power jack at the bottom of the telephone base.

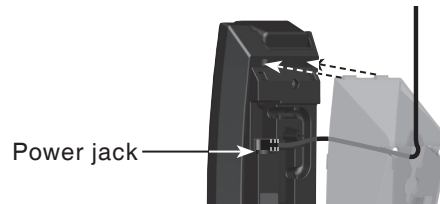

2. Insert the tabs into the upper grooves and tighten the screw to affix the mounting bracket.

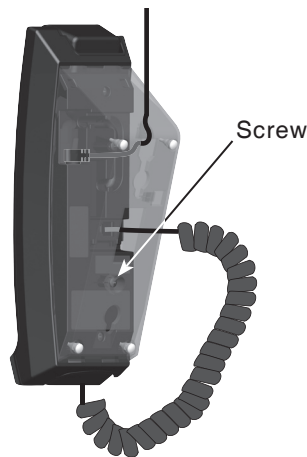

3. Plug the large end of the power adapter into the electrical outlet not controlled by a wall switch. Then connect the coiled handset cord to the telephone base.

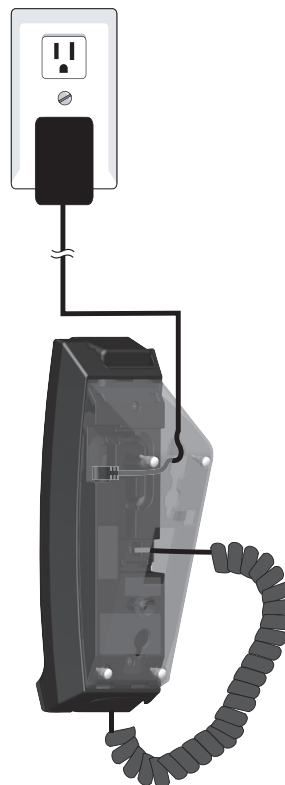

Installation

Installation

SIP contemporary trimstyle 1-line/2-line - S2310-6VDC/S2320-6VDC

Installation option - converting from desktop to wall mount position

1. Unplug the power adapter from the electrical outlet.
2. Put the corded handset aside. On its telephone base, place a coin in the slit of the wall mount clip and rotate a half turn (180 degrees). It locks into place with the protruding edge pointing towards the upper edge of the telephone base. This protruding edge holds the cordless handset when the phone is mounted on the wall.

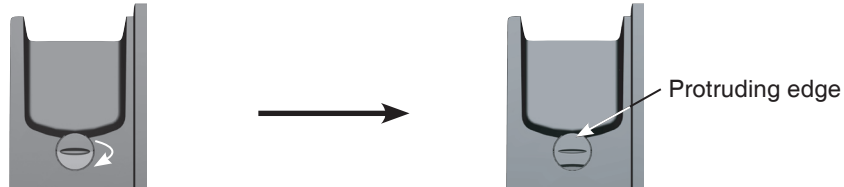

3. Loosen the screw from the mounting bracket and remove the mounting bracket from the grooves of the telephone base.

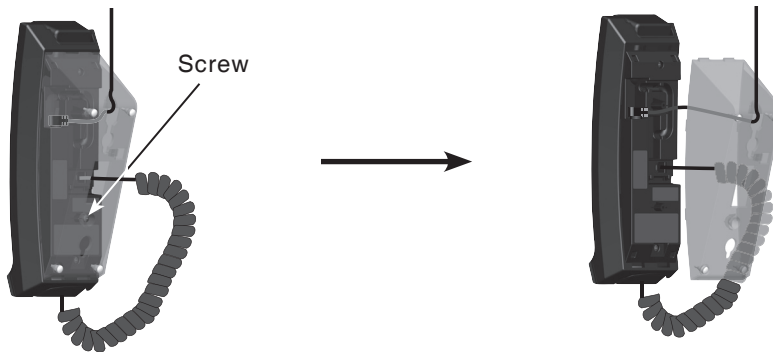

4. Rotate the mounting bracket. Insert the tabs of the mounting bracket into the lower grooves of telephone base. Then tighten the screw to affix the mounting bracket.

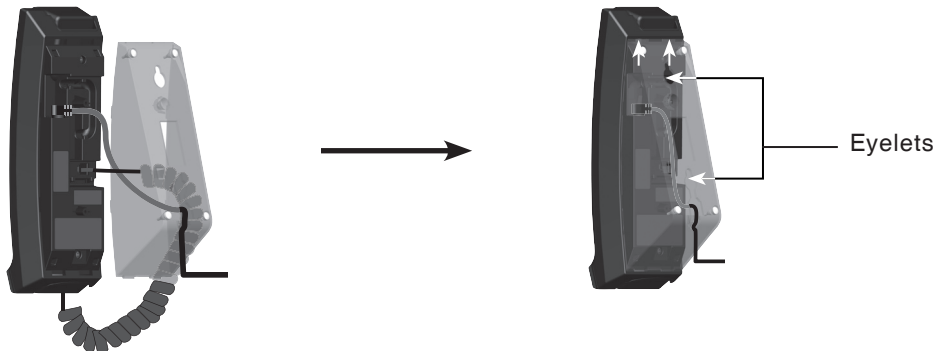

5. Mount the telephone base on the wall by aligning the eyelets with the mounting studs of the wall plate. Then slide the telephone base down on both mounting studs until it locks into place.
6. Plug the power adapter back into the electrical outlet. Then replace the handset on the telephone base cradle.

NOTE: FCC ID is shown on the back of the corded handset body after the handset cover is removed.

Installation

SIP contemporary trimstyle 1-line/2-line - S2310/S2310-6VDC/S2320/S2320-6VDC

Handset registration

An **S2310/S2310-6VDC** handset must be registered to an **S2410/CTM-S2411** telephone base before use. An **S2320/S2320-6VDC** handset must be registered to an **S2420/CTM-S2421** telephone base before use.

To register an S2310/S2310-6VDC handset:

Place the corded handset on the **S2410/CTM-S2411** telephone base cradle. Handset registration happens automatically the first time a handset is placed on the **S2410/CTM-S2411**. When the registration process completes, the **MESSAGE WAITING LED** flashes once and you hear 3 rising beeps as confirmation. Each **S2410/CTM-S2411** accommodates up to 4 handsets. When you already have 4 registered handsets, you can replace one of them by a new handset if any one of the 4 registered handsets is disconnected from the **S2410/CTM-S2411**. For example, it is out of range, or its battery is removed or depleted. The previous registered handset is then deregistered from the **S2410/CTM-S2411**.

To register an S2320/S2320-6VDC handset:

Place the corded handset on the **S2420/CTM-S2421** telephone base cradle. Handset registration happens automatically the first time a handset is placed on the **S2420/CTM-S2421**. When the registration process completes, the **MESSAGE WAITING LED** flashes once and you hear 3 rising beeps as confirmation. Each **S2420/CTM-S2421** accommodates up to 4 handsets. When you already have 4 registered handsets, you can replace one of them by a new handset if any one of the 4 registered handsets is disconnected from the **S2420/CTM-S2421**. For example, it is out of range, or its battery is removed or depleted. The previous registered handset is then deregistered from the **S2420/CTM-S2421**.

Register a handset to another telephone base

Any **S2310/S2310-6VDC** handset can register to any **S2410/CTM-S2411** telephone base before use. Any **S2320/S2320-6VDC** handset can register to any **S2420/CTM-S2421** telephone base before use.

When a registered handset is idle, place it on another telephone base. This handset automatically registers to the new telephone base.

Installation

SIP contemporary cordless 1-line/2-line - S2410/CTM-S2411/S2420/CTM-S2421

Telephone base installation

This telephone can be adapted to desktop use or mount on a standard telephone wall plate.

Installation option - desktop position

1. Turn the telephone base over with the bottom side facing up. Insert the lower tabs of the mounting bracket into the lower grooves of the telephone base. Press the upper tabs of the mounting bracket and then push into the center of the telephone base until it locks into place.

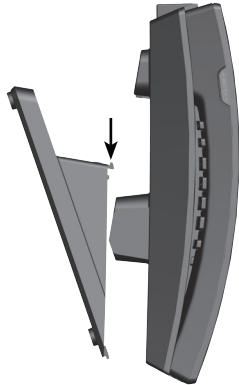

2. Plug the Cat-5 network cable into the RJ-45 LAN port on the telephone base and the network wall jack with Power over Ethernet (PoE).

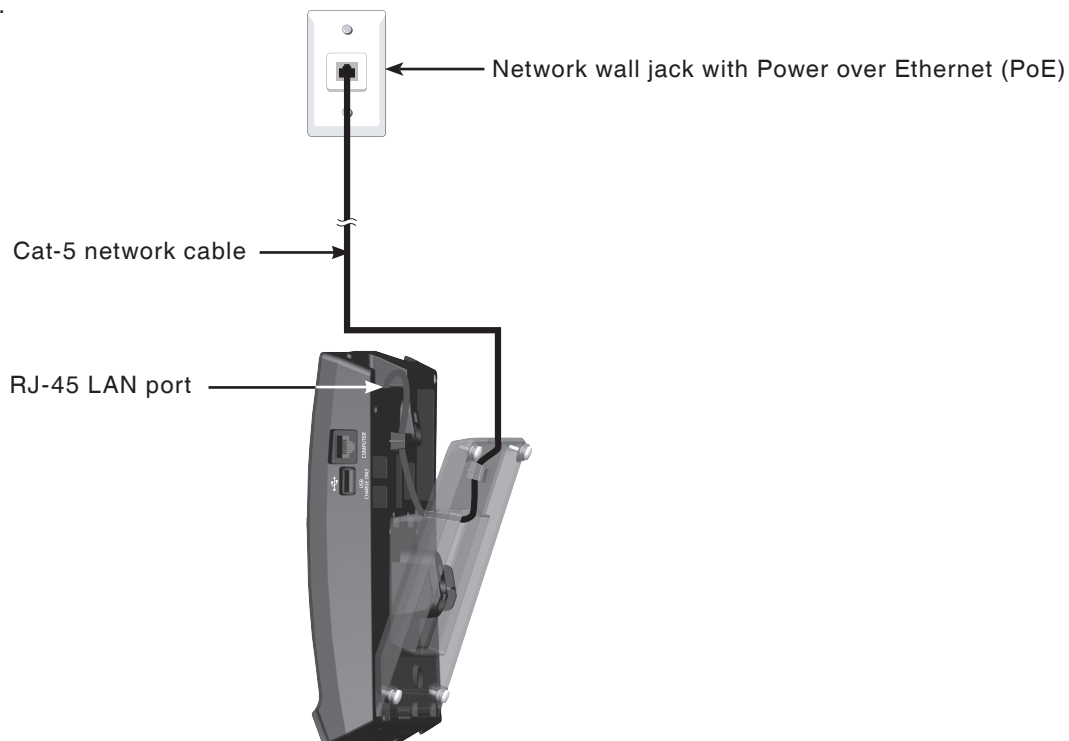

3. Once installed, the telephone begins a four-step initialization and system registration process.
 - For **S2410/CTM-S2411**: (1) The **MUTE** key and the **🔊/SPEAKER** key turn on and then go off. (2) The **MUTE** key flashes. (3) The **MUTE** key stops flashing and then the **🔊/SPEAKER** key flashes. (4) The **MESSAGE WAITING LED, LINE, MUTE** and **🔊/SPEAKER** illuminate for 500ms when initialization and system registration are successful.
 - For **S2420/CTM-S2421**: (1) The **MUTE** key and the **🔊/SPEAKER** key turn on and then go off. (2) The **MUTE** key flashes. (3) The **MUTE** key stops flashing and then the **🔊/SPEAKER** key flashes. (4) The **MESSAGE WAITING LED, LINE 1, LINE 2, CONF, MUTE** and **🔊/SPEAKER** illuminate for 500ms when initialization and system registration are successful.

If the system registration fails, the **🔊/SPEAKER** key blinks twice every second. To reset, disconnect the Cat-5 network cable from the network wall jack with Power over Ethernet (PoE) and then reconnect.

CAUTION:

Use only the supplied Cat-5 network cable. Cat-5 network cable is not designed for use in any other IT devices. Misuse of Cat-5 network cable on your other IT devices shall be prohibited. To order a replacement, call 1-888-907-2007.

Installation

SIP contemporary cordless 1-line/2-line - S2410/CTM-S2411/S2420/CTM-S2421

Installation option - converting from desktop to wall mount position

To mount the telephone base on the wall:

1. Unplug the Cat-5 network cable from the network wall jack.
2. Remove the cordless handset from the telephone base if it is cradled in the telephone base. On the telephone base, place a coin in the slit of the wall mount clip and rotate a half turn (180 degrees). It locks into place with the protruding edge pointing towards the upper edge of the telephone base. This protruding edge holds the handset when the phone is mounted on the wall.

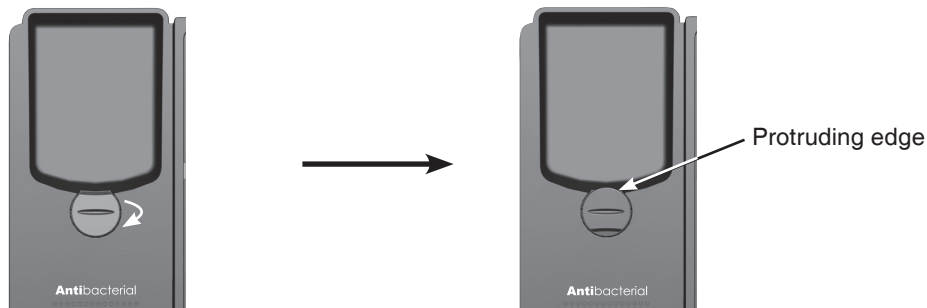

3. Turn the telephone base over with the bottom side facing up. To remove the mounting bracket, firmly press down the tabs on the mounting bracket and pull them out from the grooves on the telephone base.

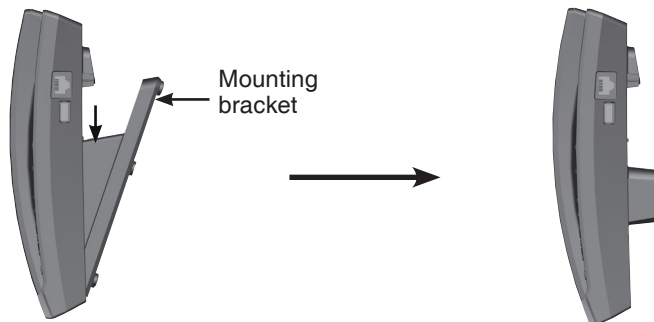

4. Mount the telephone base on the wall by aligning the eyelets with the mounting studs of the wall plate. Then slide the telephone base down on both mounting studs until it locks into place.

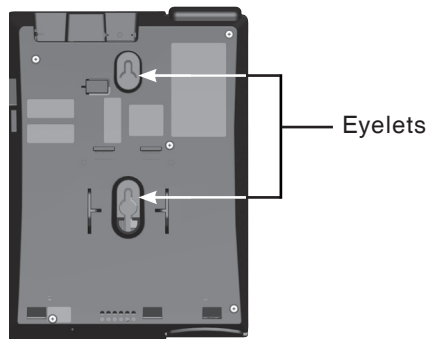

5. Plug the Cat-5 network cable back into the network wall jack with Power over Ethernet (PoE). Then replace the cordless handset on the telephone base cradle.

Installation

Installation

SIP contemporary cordless 1-line/2-line - S2410/S2420

Handset battery installation

Install the battery as shown below.

1. Gently lift the handset cover. Do not detach the speaker wires between the handset cover and the handset.
2. Plug the battery connector securely into the socket inside the handset battery compartment.
3. Place the battery with the label **THIS SIDE UP** facing up and the wires inside the battery compartment.
4. To replace the handset cover, align all the tabs on the handset cover against the corresponding grooves on the handset, then firmly push downward until all the tabs lock in the grooves. Then install the screw at the bottom of the handset.

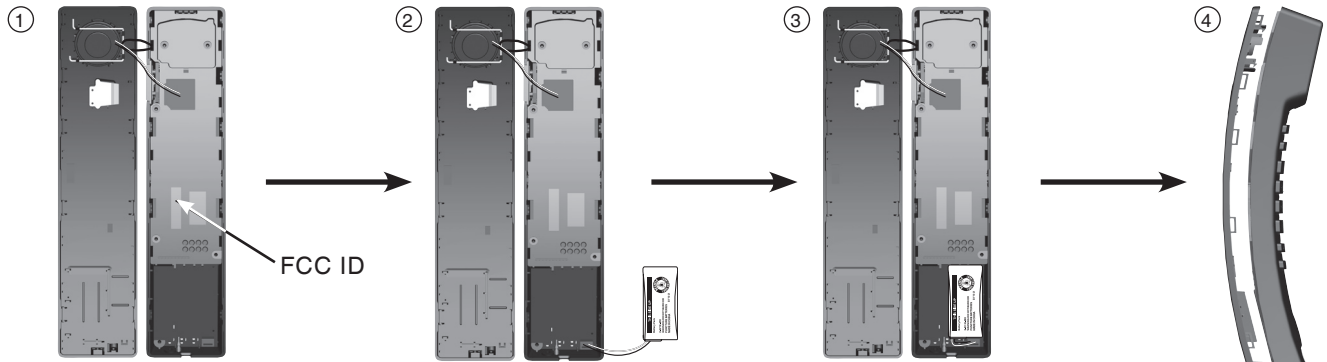

Replace a handset battery

1. Use a 5 mm standard screwdriver to open the screw cover and remove the screw. Insert the screwdriver in the provided slot and then twist and lift to open the bottom part.

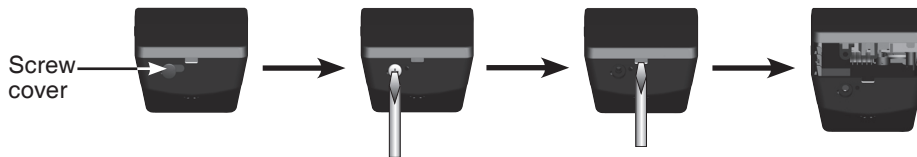

2. Use your thumb to slide along the sides of the handset carefully to release the tabs on the handset cover from the slots on the sides of the handset. Then gently detach the handset cover from the handset.



Do not detach the speaker wires between the handset cover and the handset.

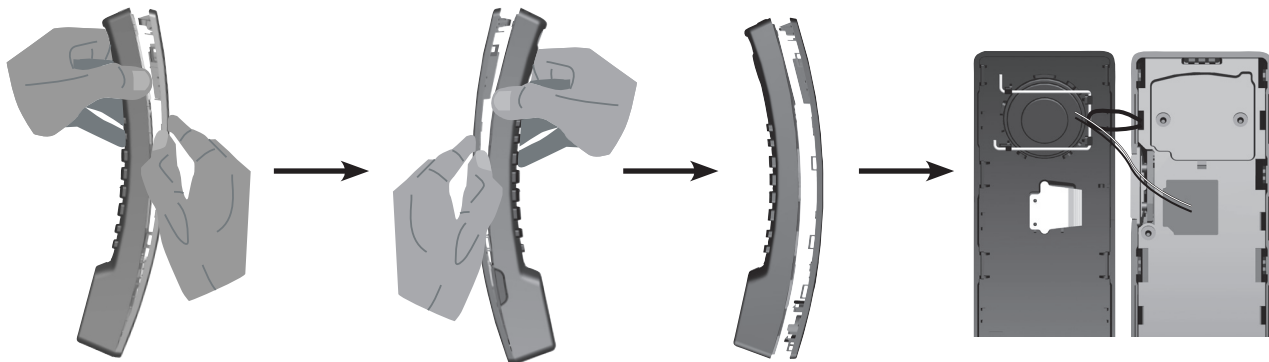

3. Unplug the battery connector from the socket and then remove the battery from the handset battery compartment.
4. Follow Step 2 to Step 4 in **Handset battery installation** above to install a new battery.

CAUTIONS:

- There may be a risk of explosion if a wrong type of handset battery is used. Use only the supplied rechargeable battery (BT264392/BT266342) or replacement battery (BT266342). To order a replacement, call 1-888-907-2007.
- FCC ID is shown on the back of the cordless handset body after the handset cover is removed.
- Dispose of used batteries according to the information in **The RBRC® seal** on page 81.

Installation

SIP contemporary cordless 1-line/2-line - S2410/S2420

Handset registration

Place the cordless handset on the telephone base cradle. Handset registration happens automatically the first time a cordless handset is placed on the telephone base. When the registration process completes, the **MESSAGE WAITING** LED flashes once and you hear 3 rising beeps as confirmation. Each telephone base accommodates up to 4 cordless handsets. When you already have 4 registered handsets, you can replace one of them by a new handset if any one of the 4 registered handsets is disconnected from the base. For example, it is out of range, or its battery is removed or depleted. The previous registered handset is then deregistered from the telephone base.

Register a handset to another telephone base

Any contemporary cordless 1-line handset can register to any contemporary cordless 1-line telephone base. Any contemporary cordless 2-line handset can register to any contemporary cordless 2-line telephone base.

When a registered cordless handset is idle, place it on another telephone base. This cordless handset automatically registers to the new telephone base.

Handset battery charging

The battery must be fully charged before using the cordless handset for the first time. The **CHARGE** LED turns on when the cordless handset is charging on the telephone base, charging base or charging stand. The battery is fully charged after 16 hours of continuous charging. For best performance, keep the cordless handset in the telephone base, charging base or charging stand when not in use.

Installation

SIP contemporary cordless 1-line/2-line - CTM-S2411/CTM-S2421

Handset battery installation

Install the battery as shown below.

1. Plug the battery connector securely into the socket inside the handset battery compartment.
2. Place the battery with the label **THIS SIDE UP** facing up and the wires inside the battery compartment.
3. To replace the handset cover, align all the tabs on the handset cover against the corresponding grooves on the handset, then firmly push downward until all the tabs lock in the grooves. Then install the screws at both ends of the handset.

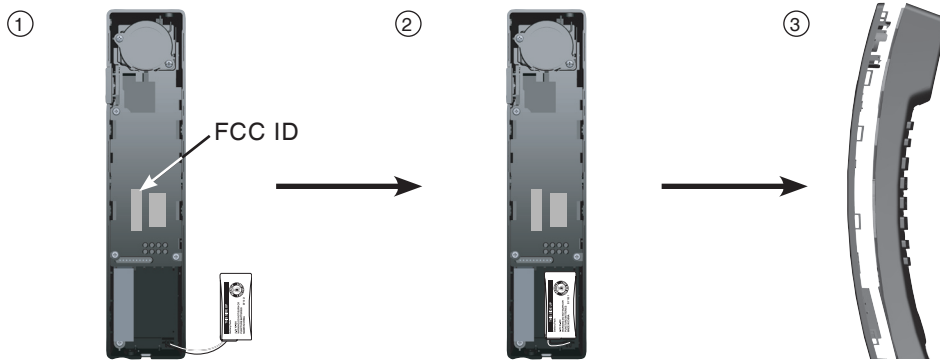

Replace a handset battery

1. Use a 5 mm standard screwdriver to open the screw cover and remove the screw.
2. Insert the screwdriver in the provided slot and then twist and lift to open the bottom part.

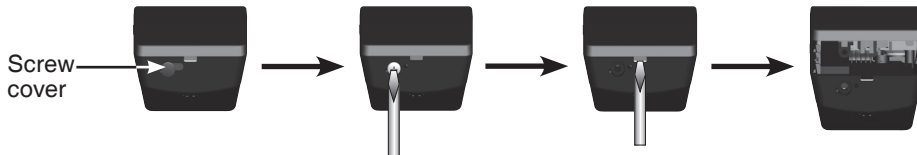

-OR-

Open the bottom part manually at the recessed area to avoid scratching the plastic.



3. Use your thumb to slide along the sides of the handset carefully to release the tabs on the handset cover from the slots on the sides of the handset. Then gently detach the handset cover from the handset.

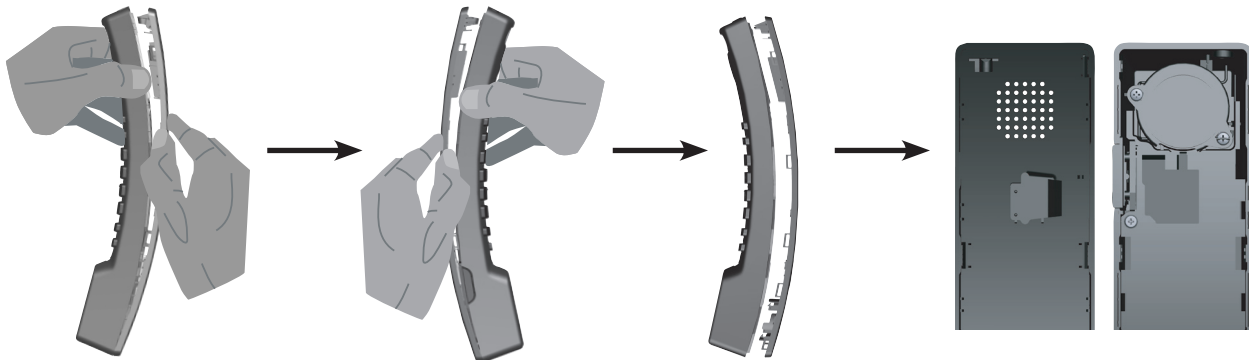

4. Unplug the battery connector from the socket and then remove the battery from the handset battery compartment.
5. Follow Step 2 to Step 4 in **Handset battery installation** above to install a new battery.

CAUTIONS:

- There may be a risk of explosion if a wrong type of handset battery is used. Use only the supplied rechargeable battery (BT264392/BT266342) or replacement battery (BT266342). To order a replacement, call 1-888-907-2007.
- FCC ID is shown on the back of the cordless handset body after the handset cover is removed.
- Dispose of used batteries according to the information in **The RBRC® seal** on page 81.

Installation

SIP contemporary cordless 1-line/2-line - CTM-S2411/CTM-S2421

Handset registration

Place the cordless handset on the telephone base cradle. Handset registration happens automatically the first time a cordless handset is placed on the telephone base. When the registration process completes, the **MESSAGE WAITING** LED flashes once and you hear 3 rising beeps as confirmation. Each telephone base accommodates up to 4 cordless handsets. When you already have 4 registered handsets, you can replace one of them by a new handset if any one of the 4 registered handsets is disconnected from the base. For example, it is out of range, or its battery is removed or depleted. The previous registered handset is then deregistered from the telephone base.

Register a handset to another telephone base

Any contemporary cordless 1-line handset can register to any contemporary cordless 1-line telephone base. Any contemporary cordless 2-line handset can register to any contemporary cordless 2-line telephone base.

When a registered cordless handset is idle, place it on another telephone base. This cordless handset automatically registers to the new telephone base.

Handset battery charging

The battery must be fully charged before using the cordless handset for the first time. The **CHARGE** LED turns on when the cordless handset is charging on the telephone base, charging base or charging stand. The battery is fully charged after 16 hours of continuous charging. For best performance, keep the cordless handset in the telephone base, charging base or charging stand when not in use.

Installation

SIP contemporary cordless 1-line/2-line accessory Petite - CTM-S241P/CTM-S242P

Accessory Petite installation

The telephone can be adapted to desktop use or mounted on a standard telephone wall plate.

Installation option - desktop position

1. Turn the accessory Petite over with the bottom side facing up. Connect the small end of the power adapter cord to the accessory Petite.

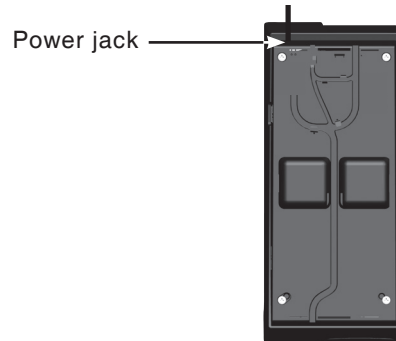

2. Position the mounting bracket as shown. Insert the two small tabs of the mounting bracket into the lower slots on the accessory Petite. Then press the large tab on the mounting bracket and firmly push it into the upper groove on the accessory Petite.



3. Install the accessory Petite as shown below. Then connect the coiled handset cord to the accessory Petite.

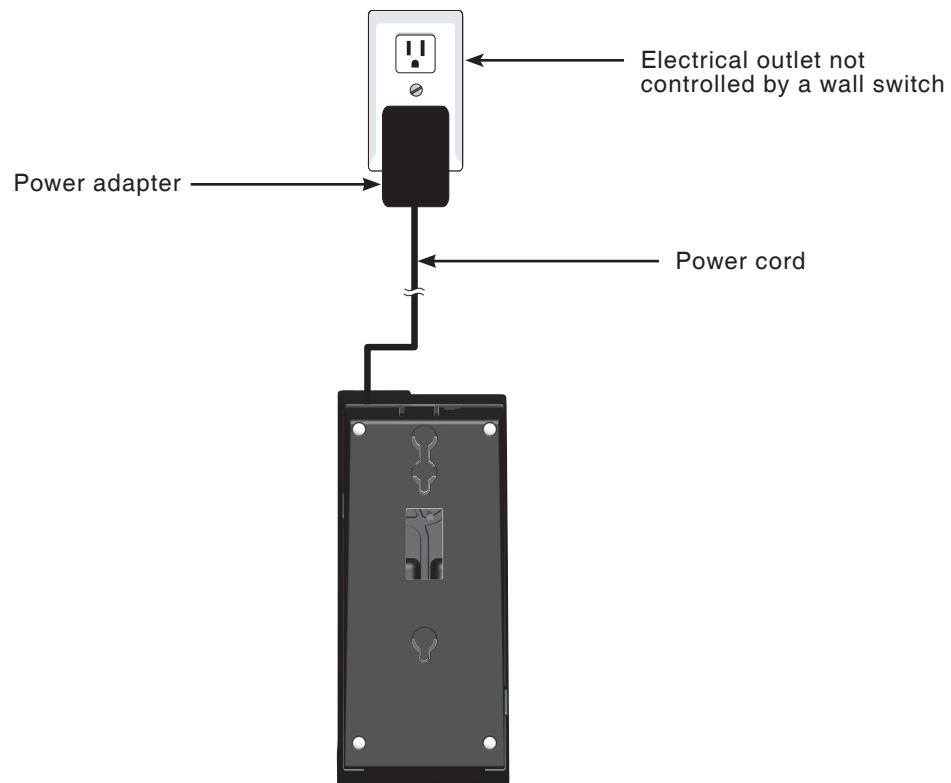

Installation

SIP contemporary cordless 1-line/2-line accessory Petite - CTM-S241P/CTM-S242P

Installation option - converting from desktop to wall mount position

To mount the accessory Petite on the wall:

1. Set aside the handset. On the accessory Petite cradle, place a coin in the slit of the wall mount clip and rotate a half turn (180 degrees). It locks into place with the protruding edge pointing towards the upper edge of the accessory Petite. This protruding edge holds the corded handset when the phone is mounted on the wall.

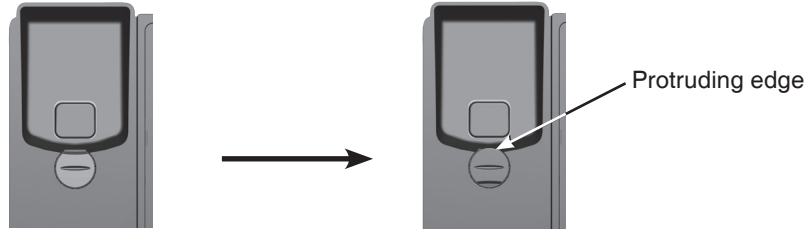

2. Press the large tab on the mounting bracket to remove it from the upper groove on the accessory Petite.

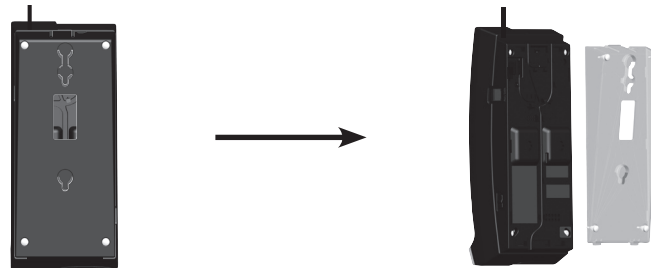

3. Turn the mounting bracket upside down. Insert the small tabs on the mounting bracket into the upper slots on the accessory Petite. Then press the large tab on the mounting bracket and firmly push it into the lower groove on the accessory Petite.

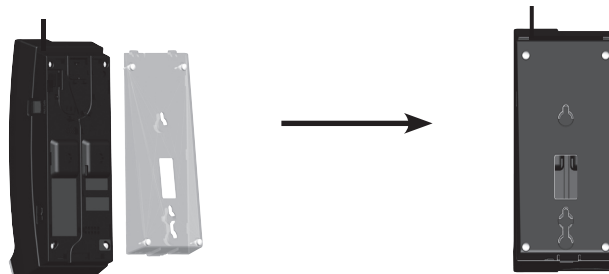

4. Mount the accessory Petite on the wall by aligning the eyelets with the mounting studs of the wall plate. Then slide the accessory Petite down on both mounting studs until it locks into place. Place the handset on the accessory Petite cradle.



Installation

Installation

SIP contemporary cordless 1-line/2-line accessory Petite - CTM-S241P/CTM-S242P

Accessory Petite registration

A **CTM-S241P** accessory Petite must be registered to a **S2410/CTM-S2411** telephone base before use. A **CTM-S242P** accessory Petite must be registered to a **S2420/CTM-S2421** telephone base before use.

To register a CTM-S241P accessory Petite:

Place the SIP cordless 1-line accessory Petite **CTM-S241P** on the **S2410/CTM-S2411** telephone base cradle. Handset registration happens automatically the first time a handset is placed on the **S2410/CTM-S2411**. When the registration process completes, the **MESSAGE WAITING** LED flashes once and you hear 3 rising beeps as confirmation. Each **S2410/CTM-S2411** accommodates up to 4 handsets or accessory Petite phones. When you already have 4 registered handsets or accessory Petite phones, you can replace one of them by a new handset or accessory Petite phone if any one of the 4 registered handsets or accessory Petite phones is disconnected from the **S2410/CTM-S2411**. For example, it is out of range, or its battery is removed or depleted. The previous registered handset or accessory Petite phone is then deregistered from the **S2410/CTM-S2411**.

To register a CTM-S242P accessory Petite:

Place the SIP cordless 2-line accessory Petite **CTM-S242P** on the **S2420/CTM-S2421** telephone base cradle. Handset registration happens automatically the first time a handset is placed on the **S2420/CTM-S2421**. When the registration process completes, the **MESSAGE WAITING** LED flashes once and you hear 3 rising beeps as confirmation. Each **S2420/CTM-S2421** accommodates up to 4 handsets or accessory Petite phones. When you already have 4 registered handsets or accessory Petite phones, you can replace one of them by a new handset or accessory Petite phone if any one of the 4 registered handsets or accessory Petite phones is disconnected from the **S2420/CTM-S2421**. For example, it is out of range, or its battery is removed or depleted. The previous registered handset or accessory Petite phone is then deregistered from the **S2420/CTM-S2421**.

Accessory Petite deregistration

When a registered accessory Petite is idle, press ***331734#** and then press **HOLD**. You hear 3 rising beeps as confirmation when the deregistration process completes.

Register an accessory Petite to another telephone base

Any SIP cordless 1-line accessory Petite **CTM-S241P** can register to any **S2410/CTM-S2411** telephone base. Any SIP cordless 2-line accessory Petite **CTM-S242P** can register to any **S2420/CTM-S2421** telephone base.

Installation

SIP contemporary charging base - C4300

Charging base installation

The charging base can be adapted to desktop use or mount on a standard telephone wall plate.

Installation option - desktop position

1. Turn the charging base over with the bottom side facing up. Connect the Cat-5 network cable into the RJ-45 LAN port on the charging base and route the cord out from the top eyelet on the mounting bracket, then position the mounting bracket as shown.

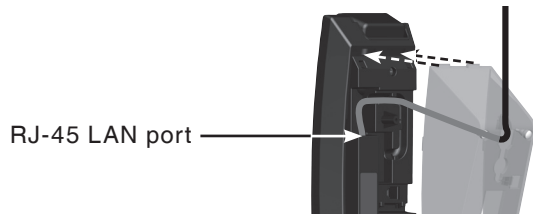

2. Insert the tabs of the mounting bracket as the direction shown below. Then tighten the screw to affix the mounting bracket.

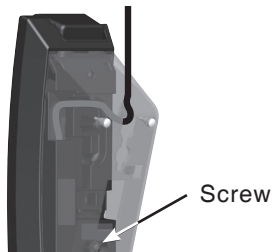

3. Plug the Cat-5 network cable into the network wall jack with Power over Ethernet (PoE).

Installation option - converting from desktop to wall mount position

1. Unplug the Cat-5 network cable from the network wall jack.
2. Remove the cordless handset from the charging base if it is cradled in the charging base. On the charging base, place a coin in the slit of the wall mount clip and rotate a half turn (180 degrees). It locks into place with the protruding edge pointing towards the upper edge of the charging base. This protruding edge holds the cordless handset when the phone is mounted on the wall.

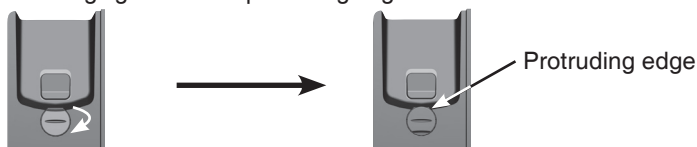

3. Loosen the screw from the mounting bracket and remove the mounting bracket from the grooves of the charging base.

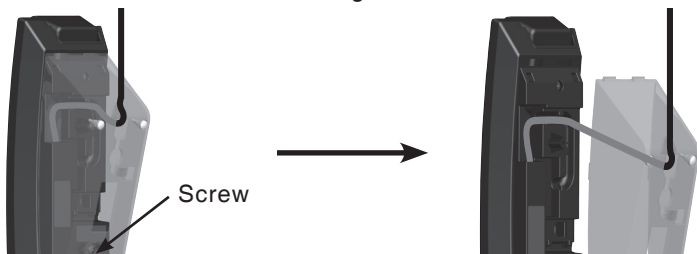

4. Rotate the mounting bracket. Insert the tabs of the mounting bracket into the lower grooves of the charging base. Then tighten the screw to affix the mounting bracket.

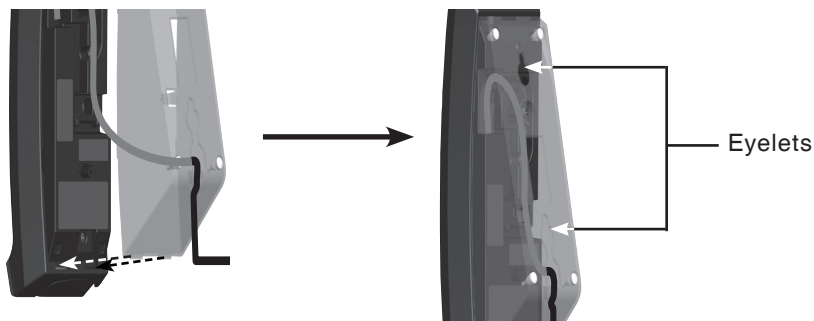

5. Mount the charging base on the wall by aligning the eyelets with the mounting studs of the wall plate. Then slide it down on both mounting studs until it locks into place.
6. Plug the Cat-5 network cable back into the network wall jack with Power over Ethernet (PoE).

Installation

SIP contemporary charging stand - C4310

Charging stand installation

The charging stand is designed for desktop use only. Install the charging stand as shown below.

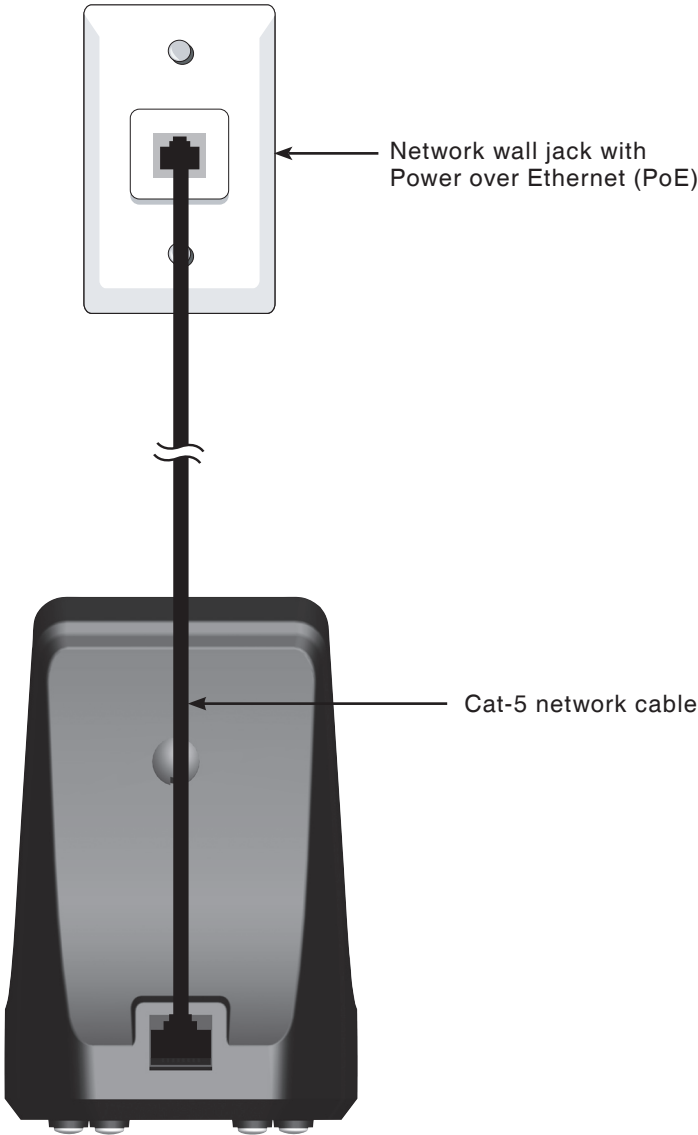

Installation

SIP contemporary cordless 1-line/2-line accessory handset - C4400/C4500/ CTM-S241HS/CTM-S242HS

Handset battery installation

Install the battery as shown below.

1. Gently lift the handset cover. Do not detach the speaker wires between the handset cover and the handset.
2. Plug the battery connector securely into the socket inside the handset battery compartment.
3. Place the battery with the label **THIS SIDE UP** facing up and the wires inside the battery compartment.
4. To replace the handset cover, align all the tabs on the handset cover against the corresponding grooves on the handset, then firmly push downward until all the tabs lock in the grooves. Then install the screw at the bottom of the handset.

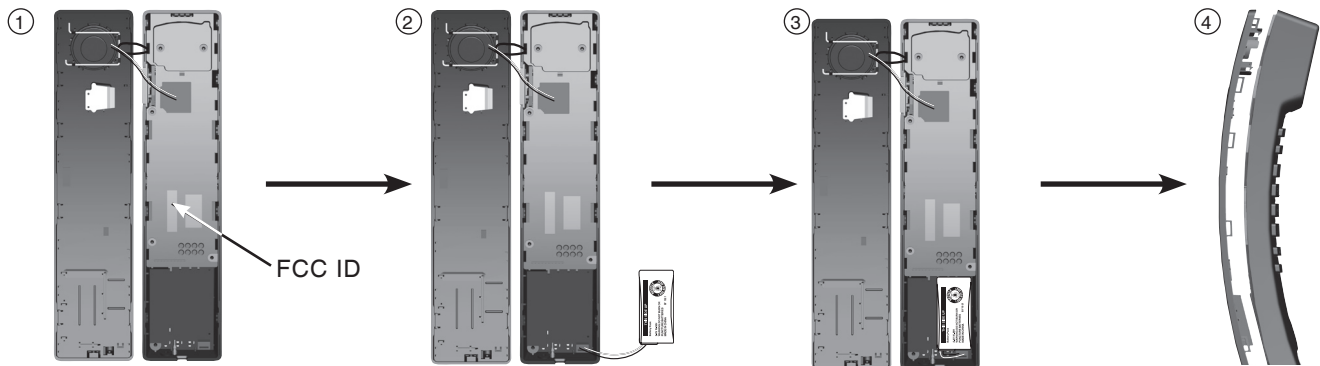

Replace a handset battery

1. Use a 5 mm standard screwdriver to open the screw cover and remove the screw. Insert the screwdriver in the provided slot and then twist and lift to open the bottom part.

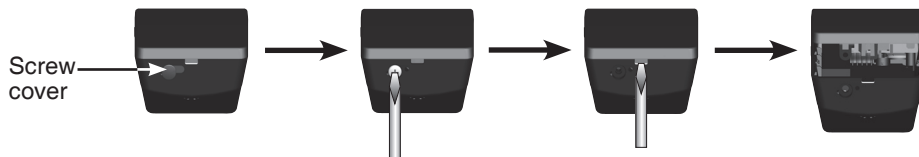

2. Use your thumb to slide along the sides of the handset carefully to release the tabs on the handset cover from the slots on the sides of the handset. Then gently detach the handset cover from the handset.



Do not detach the speaker wires between the handset cover and the handset.

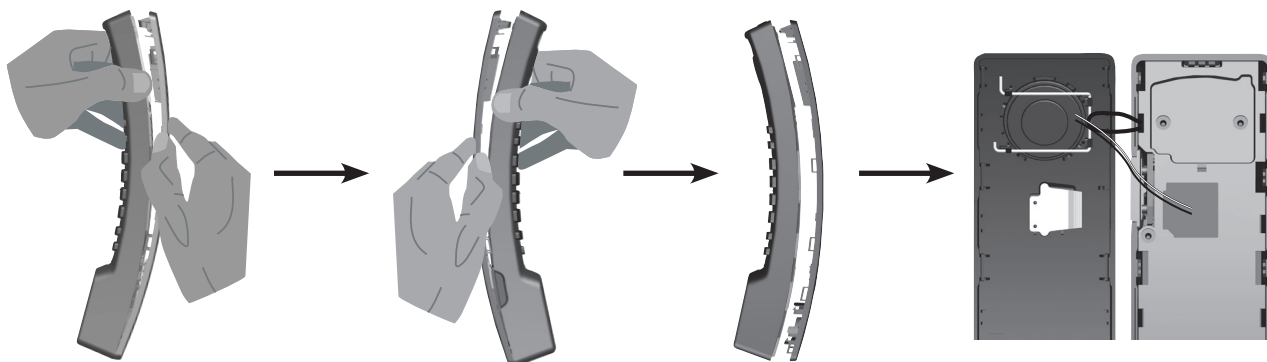

3. Unplug the battery connector from the socket and then remove the battery from the handset battery compartment.
4. Follow Step 2 to Step 4 in **Handset battery installation** above to install a new battery.

CAUTIONS:

- There may be a risk of explosion if a wrong type of handset battery is used. Use only the supplied rechargeable battery (BT264392/BT266342) or replacement battery (BT266342). To order a replacement, call 1-888-907-2007.
- FCC ID is shown on the back of the cordless handset body after the handset cover is removed.
- Dispose of used batteries according to the information in **The RBRC® seal** on page 81.

Installation

SIP contemporary cordless 1-line/2-line accessory handset - C4400/C4500/ CTM-S241HS/CTM-S242HS

Handset registration

Place the cordless handset on the telephone base cradle. Handset registration happens automatically the first time a cordless handset is placed on the telephone base. When the registration process completes, the **MESSAGE WAITING LED** flashes once and you hear 3 rising beeps as confirmation. Each telephone base accommodates up to 4 cordless handsets. When you already have 4 registered handsets, you can replace one of them by a new handset if any one of the 4 registered handsets is disconnected from the base. For example, it is out of range, or its battery is removed or depleted. The previous registered handset is then deregistered from the telephone base.

Register a handset to another telephone base

Any contemporary cordless 1-line handset can register to any contemporary cordless 1-line telephone base. Any contemporary cordless 2-line handset can register to any contemporary cordless 2-line telephone base.

When a registered cordless handset is idle, place it on another telephone base. This cordless handset automatically registers to the new telephone base.

Handset battery charging

The battery must be fully charged before using the cordless handset for the first time. The **CHARGE LED** turns on when the cordless handset is charging on the telephone base, charging base or charging stand. The battery is fully charged after 16 hours of continuous charging. For best performance, keep the cordless handset in the telephone base, charging base or charging stand when not in use.

Installation

SIP contemporary cordless 1-line/2-line accessory handset - CTM-C4401/CTM-C4501/ CTM-S241SD/CTM-S242SD

Handset battery installation

Install the battery as shown below.

1. Plug the battery connector securely into the socket inside the handset battery compartment.
2. Place the battery with the label **THIS SIDE UP** facing up and the wires inside the battery compartment.
3. To replace the handset cover, align all the tabs on the handset cover against the corresponding grooves on the handset, then firmly push downward until all the tabs lock in the grooves. Then install the screws at both ends of the handset.

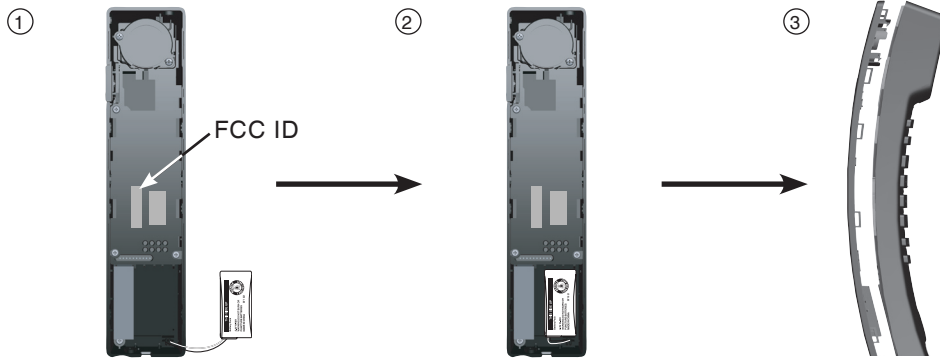

Replace a handset battery

1. Use a 5 mm standard screwdriver to open the screw cover and remove the screw.
2. Insert the screwdriver in the provided slot and then twist and lift to open the bottom part.

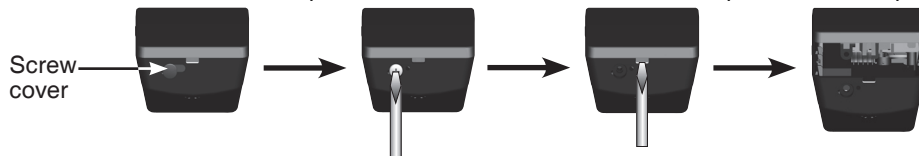

-OR-

Open the bottom part manually at the recessed area to avoid scratching the plastic.



3. Use your thumb to slide along the sides of the handset carefully to release the tabs on the handset cover from the slots on the sides of the handset. Then gently detach the handset cover from the handset.

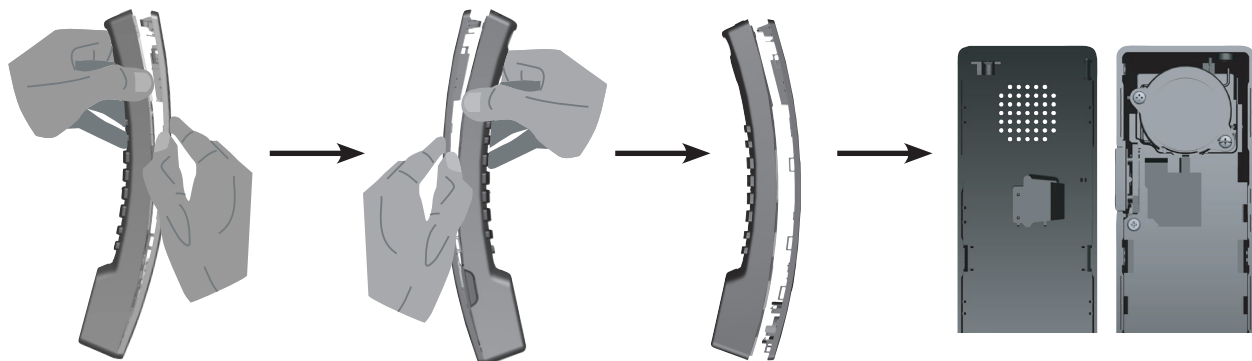

4. Unplug the battery connector from the socket and then remove the battery from the handset battery compartment.
5. Follow Step 2 to Step 4 in **Handset battery installation** above to install a new battery.

CAUTIONS:

- There may be a risk of explosion if a wrong type of handset battery is used. Use only the supplied rechargeable battery (BT264392/BT266342) or replacement battery (BT266342). To order a replacement, call 1-888-907-2007.
- FCC ID is shown on the back of the cordless handset body after the handset cover is removed.
- Dispose of used batteries according to the information in **The RBRC® seal** on page 81.

Installation

SIP contemporary cordless 1-line/2-line accessory handset - CTM-C4401/CTM-C4501/ CTM-S241SD/CTM-S242SD

Handset registration

Place the cordless handset on the telephone base cradle. Handset registration happens automatically the first time a cordless handset is placed on the telephone base. When the registration process completes, the **MESSAGE WAITING LED** flashes once and you hear 3 rising beeps as confirmation. Each telephone base accommodates up to 4 cordless handsets. When you already have 4 registered handsets, you can replace one of them by a new handset if any one of the 4 registered handsets is disconnected from the base. For example, it is out of range, or its battery is removed or depleted. The previous registered handset is then deregistered from the telephone base.

Register a handset to another telephone base

Any contemporary cordless 1-line handset can register to any contemporary cordless 1-line telephone base. Any contemporary cordless 2-line handset can register to any contemporary cordless 2-line telephone base.

When a registered cordless handset is idle, place it on another telephone base. This cordless handset automatically registers to the new telephone base.

Handset battery charging

The battery must be fully charged before using the cordless handset for the first time. The **CHARGE LED** turns on when the cordless handset is charging on the telephone base, charging base or charging stand. The battery is fully charged after 16 hours of continuous charging. For best performance, keep the cordless handset in the telephone base, charging base or charging stand when not in use.

Telephone settings

SIP classic trimstyle - S1310/S1320

SIP classic cordless 1-line/2-line - S1410/S1420

SIP contemporary trimstyle - S2310/S2310-6VDC/S2320/S2320-6VDC

SIP contemporary cordless 1-line/2-line - S2410/CTM-S2411/S2420/CTM-S2421

SIP contemporary cordless 1-line/2-line accessory Petite - CTM-S241P/CTM-S242P

All telephone settings are programmed through the administrative web portal.

Please refer to the **SIP Phone Configuration Guide** for details.

Telephone operation

SIP classic trimstyle 1-line - S1310

Receive a call

When there is an incoming call, the telephone rings and the **TALK** key flashes.

To answer a call:

Press **TALK** or **☎/SPEAKER**. The **TALK** key illuminates when the phone line is in use. The **☎/SPEAKER** key illuminates when in speakerphone mode.

Place a call

Press **TALK** or **☎/SPEAKER**. Listen for a dial tone and then dial the desired number. The **TALK** key illuminates when the phone line is in use. The **☎/SPEAKER** key illuminates when in speakerphone mode.

End a call

Press **OFF** or place the handset back in the telephone base. The call ends when all handsets hang up.

Share a call

During a call, another handset can join the call by pressing **TALK** or **☎/SPEAKER**.

Speakerphone

During a call, press **☎/SPEAKER** to switch between speakerphone mode and handset earpiece mode.

Redial

The last dialed number on the handset is stored for 15 minutes.

To redial the last dialed number:

Press **TALK** or **☎/SPEAKER** to listen for a dial tone. Then press **REDIAL**.

Volume

Listening volume can be adjusted on the handset.

To adjust the listening volume:

During a call, press **+VOLUME/-** on it to adjust the listening volume. The next call returns to the default listening volume.

Call waiting

1. When you hear a call waiting tone during a call, press **FLASH** to put the current call on hold and take the new incoming call.
2. Press **FLASH** at any time to switch back and forth between calls.

Message waiting indicator

When a voice message is received, the **MESSAGE WAITING** LEDs on the main telephone base and handsets flash.

Mute

To mute the microphone:

1. During a call, press **MUTE**. The **MUTE** light turns on when the mute function is turned on. You can hear the party on the other end but they cannot hear you.
2. Press **MUTE** again to resume the conversation. The **MUTE** light turns off.

Hold

To place a call on hold:

1. During a call, press **HOLD**. The **TALK** key flashes when the call is on hold.
2. Press **TALK** or **☎/SPEAKER** to release the call from hold, or the call will end automatically after the preset call on hold duration.

Telephone operation

SIP classic trimstyle 2-line - S1320

Receive a call

When there is an incoming call, the telephone rings and the corresponding line key flashes.

To answer a call:

Press the flashing line key, or press **☎/SPEAKER** to pick up the ringing line. The respective line key illuminates when the phone line is in use. The **☎/SPEAKER** key illuminates when in speakerphone mode.

Place a call

Press **LINE 1**, **LINE 2** or **☎/SPEAKER** to listen for a dial tone and then dial the desired number. The respective line key illuminates when the phone line is in use. The **☎/SPEAKER** key illuminates when in speakerphone mode.

End a call

Press **OFF** or place the handset back in the telephone base. The call ends when all handsets hang up.

Share a call

During a call on line 1 or line 2, another handset can join the call by pressing the respective line key or **☎/SPEAKER**.

Speakerphone

During a call, press **☎/SPEAKER** to switch between speakerphone mode and handset earpiece mode. When the telephone is idle, press **☎/SPEAKER**. The first available line is selected, starting with line 1.

Redial

The last dialed number is stored for 15 minutes.

To redial the last dialed number:

Press **LINE 1**, **LINE 2** or **☎/SPEAKER** to listen for a dial tone. Then press **REDIAL**.

Volume

Listening volume can be adjusted on the handset.

To adjust the listening volume:

During a call on the handset, press **+VOLUME/-** on it to adjust the listening volume. The next call returns to the default listening volume.

Call waiting

Call waiting supports 2-line phones configured as single SIP account only. To change the SIP account settings, refer to the **SIP Phone Configuration Guide** for details.

1. When you hear a call waiting tone during a call, press the corresponding line key to put the current call on hold and take the new incoming call.
2. Press the corresponding line key at any time to switch back and forth between calls.

Message waiting indicator (only for line 1)

When a voice message is received, the **MESSAGE WAITING** LEDs on the main telephone base and handsets flash.

Mute

To mute the microphone:

1. During a call, press **MUTE**. The **MUTE** light turns on when the mute function is turned on. You can hear the party on the other end but they cannot hear you.
2. Press **MUTE** again to resume the conversation. The **MUTE** light turns off.

Hold

To place a call on hold:

1. During a call, press **HOLD**. The corresponding line key flashes when the call is on hold.
2. Press the flashing line key or **☎/SPEAKER** to release the call from hold, or the call will end automatically after the preset call on hold duration. When both lines are on hold, press **☎/SPEAKER** only releases the call from hold on line 1.

Telephone operation

SIP classic trimstyle 2-line - S1320

Conference call

This telephone allows three-way conversations.

To initiate a conference call:

1. Place a call to the first party.
2. Press **HOLD** to place the first party on hold.
3. Place a second call on the other line.
4. Once the second party is on the line, press **CONF** to start a three-way conference.

To initiate a conference call while both calls are on hold:

Press **CONF** to start a three-way conference.

To end a conference call:

- Press **OFF** on the handset, or place the handset back in the telephone base.
- When there is more than one handset on the conference call, the call ends when all handsets hang up.

Telephone operation

SIP classic cordless 1-line - S1410

Using the cordless handset and the telephone base

The cordless handset and the telephone base speakerphone cannot be used on the same call. However, calls can be switched between the corded handset and the telephone base speakerphone.

When the cordless handset or the telephone base is in use, the **TALK** key on the cordless handset and the **LINE** key on the telephone base illuminate.

Receive a call

When there is an incoming call, the telephone rings, the **LINE** key and the **MESSAGE WAITING** LED on the telephone base flash, and the **TALK** key on the cordless handset flashes.

To answer a call using the cordless handset while it is not on the telephone base or charging base:

On the cordless handset, press **TALK** or **☎/SPEAKER**. The **TALK** key illuminates when the phone line is in use. The **☎/SPEAKER** key illuminates when in speakerphone mode.

To answer a call using the cordless handset while it is cradled on the telephone base or charging base:

Lift the cordless handset from the telephone base or charging base. The **TALK** key illuminates when the phone line is in use. The **☎/SPEAKER** key illuminates when in speakerphone mode.

To answer a call using the telephone base:

On the telephone base, press **LINE** or **☎/SPEAKER**. The **LINE** key illuminates when the phone line is in use. The **☎/SPEAKER** key illuminates when in speakerphone mode.

Place a call

To place a call using the cordless handset:

On the cordless handset, press **TALK** or **☎/SPEAKER**. Listen for a dial tone and then dial the desired number. The **TALK** key illuminates when the phone line is in use. The **☎/SPEAKER** key illuminates when in speakerphone mode.

To place a call using the telephone base:

On the telephone base, press **LINE** or **☎/SPEAKER**. Listen for a dial tone and then dial the desired number, or press a Speed Dial key to dial a programmed number. The **LINE** key illuminates when the phone line is in use. The **☎/SPEAKER** key illuminates when in use.

End a call

To end a call when using the cordless handset:

Press **OFF** on the cordless handset, or place it in the telephone base or charging base. The call ends when all handsets hang up.

To end a call when using the telephone base:

Press **LINE** or **☎/SPEAKER**.

Switch a call between the cordless handset and the telephone base speakerphone

- To switch a call from the cordless handset to the telephone base speakerphone, press **LINE** or **☎/SPEAKER** on the telephone base.
- To switch a call from the telephone base speakerphone to the cordless handset which is not on the telephone base cradle, press **TALK** or **☎/SPEAKER** on the cordless handset.
- To switch a call from the telephone base speakerphone to the cordless handset which is cradled on the telephone base, lift the cordless handset from the telephone base.

Share a call

During a call, another handset can join the call by pressing **TALK** or **☎/SPEAKER**.

Handset speakerphone

During a call, press **☎/SPEAKER** on the cordless handset to switch between speakerphone mode and handset earpiece mode.

Redial

The last dialed number on the cordless handset or the telephone base is stored for 15 minutes.

To redial the last dialed number from the cordless handset:

Press **TALK** or **☎/SPEAKER** to listen for a dial tone. Then press **REDIAL**.

To redial the last dialed number from the telephone base:

Press **LINE** or **☎/SPEAKER** to listen for a dial tone. Then press **REDIAL**.

Telephone operation

SIP classic cordless 1-line - S1410

Volume

Listening volume can be adjusted on the cordless handset and the telephone base.

To adjust the listening volume:

- During a call on the cordless handset, press **+ / VOLUME / -** on it to adjust the listening volume. The next call returns to the default listening volume.
- During a call on the telephone base, press **+ / - VOLUME** on it to adjust the listening volume. The next call returns to the default listening volume.

Ringer volume of the telephone base can be adjusted.

To adjust the ringer volume of the telephone base:

When the telephone base is idle, press **+ / - VOLUME** on it to adjust the ringer volume.

Call waiting

1. When you hear a call waiting tone during a call, press **FLASH** to put your current call on hold and take the new incoming call.
2. Press **FLASH** at any time to switch back and forth between calls.

Message waiting indicator

When a voice message is received, the **MESSAGE WAITING** LEDs on the telephone base and handset flash.

Mute

To mute the microphone:

1. During a call, press **MUTE**. The **MUTE** light turns on when the mute function is turned on. You can hear the party on the other end but they cannot hear you.
2. Press **MUTE** again to resume the conversation. The **MUTE** light turns off.

Hold

To place a call on hold on the cordless handset:

1. During a call, press **HOLD** on the cordless handset. The **TALK** key on the cordless handset and the **LINE** key on the telephone base flash when the call is on hold.
2. Press **TALK** or **☎ / SPEAKER** to release the call from hold, or the call will end automatically after the preset call on hold duration.

To place a call on hold on the telephone base:

1. During a call, press **HOLD** on the telephone base. The **LINE** key on the telephone base and the **TALK** key on the cordless handset flash when the call is on hold.
2. Press **LINE** or **☎ / SPEAKER** to release the call from hold, or the call will end automatically after the preset call on hold duration.

Find handset

Use this feature to find all registered cordless handsets.

To start paging:

Press **📞 / FIND HANDSET** on the telephone base when the phone is not in use. All idle cordless handsets beep for 60 seconds.

To end paging:

- Press **📞 / FIND HANDSET** again on the telephone base.

-OR-

- Press any key on the cordless handset to stop the paging tone.

Computer port

You can route your computer through the **COMPUTER** port (RJ-45) on the side of the telephone base to get Internet access.

USB port

The **🔌** port on the side of the telephone base can be used for charging devices (up to 500mA @ 5V). Charging will be suspended when there is an incoming call or the telephone is in use.

Telephone operation

SIP classic cordless 2-line - S1420

Using the cordless handset and the telephone base

The cordless handset and the telephone base cannot be used on the same call. However, calls can be switched between the cordless handset and the telephone base speakerphone.

When the cordless handset or the telephone base is in use, the corresponding line keys on the cordless handset and the telephone base illuminate.

Receive a call

When there is an incoming call, the telephone rings. The respective line key and the **MESSAGE WAITING** LED on the telephone base flash, and the respective line key on the cordless handset flashes.

To answer a call using the cordless handset while it is not on the telephone base or charging base:

On the cordless handset, press the flashing line key, or **☎/SPEAKER** to pick up the ringing line. The respective line key illuminates when the phone line is in use. The **☎/SPEAKER** key illuminates when in speakerphone mode.

To answer a call using the cordless handset while it is cradled on the telephone base or charging base:

Pick up the cordless handset from the telephone base or charging base. It automatically connects to the ringing line. The respective line key illuminates when the phone line is in use.

To answer a call using the telephone base:

On the telephone base, press the flashing line key, or **☎/SPEAKER** to pick up the ringing line. The respective line key illuminates when the phone line is in use. The **☎/SPEAKER** key illuminates when in speakerphone mode.

Place a call

To place a call using the cordless handset:

On the cordless handset, press **LINE 1**, **LINE 2** or **☎/SPEAKER**. Listen for a dial tone and then dial the desired number. The respective line key illuminates when the phone line is in use. The **☎/SPEAKER** key illuminates when in speakerphone mode.

To place a call using the telephone base:

On the telephone base, press **LINE 1**, **LINE 2** or **☎/SPEAKER**. Listen for a dial tone and then dial the desired number, or press a Speed Dial key to dial a programmed number. The line key illuminates when the phone line is in use. The **☎/SPEAKER** key illuminates when in speakerphone mode.

End a call

To end a call when using the cordless handset:

Press **OFF** on the cordless handset or place it in the telephone base or charging base. The call ends when all handsets hang up.

To end a call when using the telephone base:

Press **☎/SPEAKER** or the respective line key on the telephone base.

Switch a call between the cordless handset and the telephone base speakerphone

- To switch a call from the cordless handset to the telephone base speakerphone, press the respective line key or **☎/SPEAKER** on the telephone base.
- To switch a call from the telephone base speakerphone to the cordless handset which is not on the telephone base cradle, press the respective line key or **☎/SPEAKER** on the cordless handset.
- To switch a call from the telephone base speakerphone to the cordless handset which is cradled on the telephone base, lift the cordless handset from the telephone base.

Share a call

During a call on line 1 or line 2, another handset can join the call by pressing the respective line key or **☎/SPEAKER**.

Handset speakerphone

During a call on the cordless handset, press **☎/SPEAKER** on the cordless handset to switch between speakerphone mode and handset earpiece mode.

Speakerphone

When the telephone is idle, press **☎/SPEAKER** on the cordless handset or the telephone base. The first available line is selected, starting with line 1.

Telephone operation

SIP classic cordless 2-line - S1420

Redial

The last dialed number on the cordless handset or the telephone base is stored for 15 minutes.

To redial the last dialed number from the handset or the telephone base:

Press **LINE 1**, **LINE 2** or **☎)/SPEAKER**. Listen for a dial tone. Then press **REDIAL**.

Volume

Listening volume can be adjusted on the cordless handset and the telephone base.

To adjust the listening volume:

- During a call on the cordless handset, press **+/VOLUME/-** on it to adjust the listening volume. The next call returns to the default listening volume.
- During a call on the telephone base, press **+/- VOLUME** on it to adjust the listening volume. The next call returns to the default listening volume.

Ringer volume of the telephone base can be adjusted.

To adjust the ringer volume of the telephone base:

When the telephone base is idle, press **+/- VOLUME** on it to adjust the ringer volume.

Call waiting

Call waiting supports 2-line phones configured as single SIP account only. To change the SIP account settings, refer to the **SIP Phone Configuration Guide** for details.

1. When you hear a call waiting tone during a call, press the corresponding line key to put the current call on hold and take the new incoming call.
2. Press the corresponding line key at any time to switch back and forth between calls.

Message waiting indicator (only for line 1)

When a voice message is received, the **MESSAGE WAITING** LEDs on the telephone base and handset flash.

Mute

To mute the microphone:

1. During a call, press **MUTE** on the cordless handset or the telephone base. The **MUTE** lights turns off when the mute function is turned on. You can hear the party on the other end but they cannot hear you.
2. Press **MUTE** again to resume the conversation. The **MUTE** light turns off.

Hold

To place a call on hold:

1. During a call, press **HOLD** on the cordless handset or the telephone base. The corresponding line key flashes when the call is on hold.
2. Press the flashing line key or **☎)/SPEAKER** to release the call from hold, or the call will end automatically after the preset call on hold duration. When both lines are on hold, press **☎)/SPEAKER** only releases the call from hold on line 1.

Telephone operation

SIP classic cordless 2-line - S1420

Conference call

This telephone allows three-way conversations.

To initiate a conference call:

1. Place a call to the first party.
2. Press **HOLD** to place the first party on hold.
3. Place a second call on the other line.
4. Once the second party is on the line, press **CONF** to start a three-way conference.

To initiate a conference call while both calls are on hold:

Press **CONF** to start a three-way conference.

To switch a conference call from the telephone base to the cordless handset:

- During a conference call on the telephone base, press **☎/SPEAKER** or **CONF** on the cordless handset.
- During a conference call on the telephone base, press **HOLD** on the telephone base and then press **CONF** on the cordless handset.

To switch a conference call from the cordless handset to the telephone base:

- During a conference call on the cordless handset, press **☎/SPEAKER** or **CONF** on the telephone base.
- During a conference call on the cordless handset, press **HOLD** on the cordless handset and then press **CONF** on the telephone base.

To end a conference call:

- When the conference call is in speakerphone mode, press **CONF** or **☎/SPEAKER** to end.
- When the conference call is in handset earpiece mode, press **OFF** on the cordless handset or place the cordless handset back in the telephone base to end.
- When there is more than one handset on the conference call, the call ends when all telephones hang up.

Find handset

Use this feature to find all registered cordless handsets.

To start paging:

Press **📞/FIND HANDSET** on the telephone base when the phone is not in use. All idle cordless handsets beep for 60 seconds.

To end paging:

- Press **📞/FIND HANDSET** again on the telephone base.

-OR-

- Press any key on the cordless handset to stop the paging tone.

Computer port

You can route your computer through the **COMPUTER** port (RJ-45) on the side of the telephone base to get Internet access.

USB port

The **USB** port on the side of the telephone base can be used for charging devices (up to 500mA @ 5V). Charging will be suspended when there is an incoming call or the telephone is in use.

Telephone operation

SIP contemporary trimstyle 1-line - S2310/S2310-6VDC

Receive a call

When there is an incoming call, the telephone rings and the **TALK** key flashes.

To answer a call:

Press **TALK** or **☎/SPEAKER**. The **TALK** key illuminates when the phone line is in use. The **☎/SPEAKER** key illuminates when in speakerphone mode.

Place a call

Press **TALK** or **☎/SPEAKER**. Listen for a dial tone and then dial the desired number. The **TALK** key illuminates when the phone line is in use. The **☎/SPEAKER** key illuminates when in speakerphone mode.

End a call

Press **OFF** or place the handset back in its telephone base. The call ends when all handsets hang up.

Share a call

During a call, another handset can join the call by pressing **TALK** or **☎/SPEAKER**.

Speakerphone

During a call, press **☎/SPEAKER** to switch between speakerphone mode and handset earpiece mode.

Redial

The last dialed number on the handset is stored for 15 minutes.

To redial the last dialed number:

Press **TALK** or **☎/SPEAKER** to listen for a dial tone. Then press **REDIAL**.

Volume

Listening volume can be adjusted on the handset.

To adjust the listening volume:

During a call, press **-/VOLUME/+** on it to adjust the listening volume. The next call returns to the default listening volume.

Call waiting

1. When you hear a call waiting tone during a call, press **FLASH** to put the current call on hold and take the new incoming call.
2. Press **FLASH** at any time to switch back and forth between calls.

Message waiting indicator

When a voice message is received, the **MESSAGE WAITING** LEDs on the main telephone base and handsets flash.

Mute

To mute the microphone:

1. During a call, press **MUTE**. The **MUTE** light turns on when the mute function is turned on. You can hear the party on the other end but they cannot hear you.
2. Press **MUTE** again to resume the conversation. The **MUTE** light turns off.

Hold

To place a call on hold:

1. During a call, press **HOLD**. The **TALK** key flashes when the call is on hold.
2. Press **TALK** or **☎/SPEAKER** to release the call from hold, or the call will end automatically after the preset call on hold duration.

Telephone operation

SIP contemporary trimstyle 1-line - S2310/S2310-6VDC

Intercom

Use this feature for conversations between two handsets.

To initiate an intercom call:

- Press **INTERCOM** when the handset is not in use. It beeps and the **INTERCOM** key flashes. All destination cordless handsets and the main telephone base ring. The **INTERCOM** keys on other cordless handsets and **INT** key on the main telephone base flash.

To initiate an intercom call during a call:

- During a call, press **HOLD** to put the current call on hold. Then press **INTERCOM**. It beeps and the **INTERCOM** key flashes. All destination cordless handsets and the main telephone base ring. The **INTERCOM** keys on other cordless handsets and **INT** key on the main telephone base flash.

To answer an intercom call:

Press **INTERCOM** on the handset.

To answer an incoming call during an intercom call:

Press **TALK** on the handset. The intercom call ends automatically.

To end an intercom call:

Press **OFF** or place the handset back in its telephone base.

Telephone operation

SIP contemporary trimstyle 2-line - S2320/S2320-6VDC

Receive a call

When there is an incoming call, the telephone rings and the corresponding line key flashes.

To answer a call:

Press the flashing line key, or press **☎/SPEAKER** to pick up the ringing line. The respective line key illuminates when the phone line is in use. The **☎/SPEAKER** key illuminates when in speakerphone mode.

Place a call

Press **LINE 1**, **LINE 2** or **☎/SPEAKER**. Listen for a dial tone and then dial the desired number. The respective line key illuminates when the phone line is in use. The **☎/SPEAKER** key illuminates when in speakerphone mode.

End a call

Press **OFF** or place the handset back in the telephone base. The call ends when all handsets hang up.

Share a call

During a call on line 1 or line 2, another handset can join the call by pressing the respective line key or **☎/SPEAKER**.

Speakerphone

During a call, press **☎/SPEAKER** to switch between speakerphone mode and handset earpiece mode.

When the telephone is idle, press **☎/SPEAKER**. The first available line is selected, starting with line 1.

Redial

The last dialed number is stored for 15 minutes.

To redial the last dialed number:

Press **LINE 1**, **LINE 2** or **☎/SPEAKER**. Listen for a dial tone. Then press **REDIAL**.

Volume

Listening volume can be adjusted on the handset.

To adjust the listening volume:

During a call on the handset, press **-VOLUME/+** on it to adjust the listening volume. The next call returns to the default listening volume.

Call waiting

Call waiting supports 2-line phones configured as single SIP account only. To change the SIP account settings, refer to the **SIP Phone Configuration Guide** for details.

1. When you hear a call waiting tone during a call, press the corresponding line key to put the current call on hold and take the new incoming call.
2. Press the corresponding line key at any time to switch back and forth between calls.

Message waiting indicator (only for line 1)

When a voice message is received, the **MESSAGE WAITING** LEDs on the main telephone base and handsets flash.

Mute

To mute the microphone:

1. During a call, press **MUTE**. The **MUTE** light turns on when the mute function is turned on. You can hear the party on the other end but they cannot hear you.
2. Press **MUTE** again to resume the conversation. The **MUTE** light turns off.

Hold

To place a call on hold:

1. During a call, press **HOLD**. The corresponding line key flashes when the call is on hold.
2. Press the flashing line key or **☎/SPEAKER** to release the call from hold, or the call will end automatically after the preset call on hold duration. When both lines are on hold, press **☎/SPEAKER** only releases the call from hold on line 1.

Telephone operation

SIP contemporary trimstyle 2-line - S2320/S2320-6VDC

Intercom

Use this feature for conversations between two handsets.

To initiate an intercom call:

- Press **INTERCOM** when the handset is not in use. It beeps and the **INTERCOM** key flashes. All destination cordless handsets and the main telephone base ring. The **INTERCOM** keys on the cordless handsets and **INT** key on the main telephone base flash.

To initiate an intercom call during a call:

- During a call, press **HOLD** to put the current call on hold. Then press **INTERCOM**. It beeps and the **INTERCOM** key flashes. All destination cordless handsets and the main telephone base ring. The **INTERCOM** keys on the cordless handsets and **INT** key on the main telephone base flash.

To answer an intercom call:

Press **INTERCOM** on the handset.

To answer an incoming call during an intercom call:

Press the flashing line key on the handset. The intercom call ends automatically.

To end an intercom call:

Press **OFF** or place the handset back in its telephone base.

Conference call

This telephone allows three-way conversations.

To initiate a conference call:

1. Place a call to the first party.
2. Press **HOLD** to place the first party on hold.
3. Place a second call on the other line.
4. Once the second party is on the line, press **CONF** to start a three-way conference.

To initiate a conference call while both calls are on hold:

Press **CONF** to start a three-way conference.

To end a conference call:

- Press **OFF** on the handset.
- Place the handset back in its telephone base.
- When there is more than one handset on the conference call, the call ends when all handsets hang up.

Telephone operation

SIP contemporary cordless 1-line - S2410/CTM-S2411

Using the cordless handset and the telephone base

The cordless handset and the telephone base cannot be used on the same call. However, calls can be switched between the cordless handset and the telephone base speakerphone.

When the cordless handset or the telephone base is in use, the **TALK** key on the cordless handset and the **LINE** key on the telephone base illuminate.

Receive a call

When there is an incoming call, the telephone rings. The **LINE** key and the **MESSAGE WAITING** LED on the telephone base flash, and the **TALK** key on the cordless handset flashes.

To answer a call using the cordless handset while it is not on the telephone base, charging base or charging stand:

On the cordless handset, press **TALK** or **☎/SPEAKER**. The **TALK** key illuminates when phone line is in use. The **☎/SPEAKER** key illuminates when in speakerphone mode.

To answer a call using the cordless handset while it is cradled on the telephone base, charging base or charging stand:

Lift the cordless handset from the telephone base, charging base or charging stand. The **TALK** key illuminates when the phone line is in use. The **☎/SPEAKER** key illuminates when in speakerphone mode.

To answer a call using the telephone base:

On the telephone base, press **LINE** or **☎/SPEAKER**. The **LINE** key illuminates when the phone line is in use. The **☎/SPEAKER** key illuminates when in speakerphone mode.

Place a call

To place a call using the cordless handset:

On the cordless handset, press **TALK** or **☎/SPEAKER**. Listen for a dial tone and then dial the desired number. The **TALK** key illuminates when the phone line is in use. The **☎/SPEAKER** key illuminates when in speakerphone mode.

To place a call using the telephone base:

On the telephone base, press **LINE** or **☎/SPEAKER**. Listen for a dial tone and then dial the desired number, or press a Speed Dial key to dial a programmed number. The **LINE** key illuminates when the phone line is in use. The **☎/SPEAKER** key illuminates when in speakerphone mode.

End a call

To end a call when using the cordless handset:

Press **OFF** on the cordless handset or place it in the telephone base, charging base or charging stand. The call ends when all handsets hang up.

To end a call when using the telephone base:

Press **LINE** or **☎/SPEAKER**.

Switch a call between the cordless handset and the telephone base speakerphone

- To switch a call from the cordless handset to the telephone base speakerphone, press **☎/SPEAKER** on the telephone base.
- To switch a call from the telephone base speakerphone to the cordless handset which is not on the telephone base cradle, press **TALK** or **☎/SPEAKER** on the cordless handset.
- To switch a call from the telephone base speakerphone to the cordless handset which is cradled on the telephone base, lift the cordless handset from the telephone base.

Share a call

During a call, another handset can join the call by pressing **TALK** or **☎/SPEAKER**.

Handset speakerphone

During a call, press **☎/SPEAKER** on the cordless handset to switch between speakerphone mode and handset earpiece mode.

Redial

The last dialed number on the cordless handset or the telephone base is stored for 15 minutes.

To redial the last dialed number from the cordless handset:

Press **TALK** or **☎/SPEAKER** to listen for a dial tone. Then press **REDIAL**.

To redial the last dialed number from the telephone base:

Press **LINE** or **☎/SPEAKER** to listen for a dial tone. Then press **REDIAL**.

Telephone operation

SIP contemporary cordless 1-line - S2410/CTM-S2411

Volume

Listening volume can be adjusted on the cordless handset and the telephone base.

To adjust the listening volume:

- During a call on the handset, press **-/VOLUME/+** on it to adjust the listening volume. The next call returns to the default listening volume.
- During a call on the telephone base, press **+/VOLUME** or **-/VOLUME** on it to adjust the listening volume. The next call returns to the default listening volume.

Ringer volume of the telephone base can be adjusted.

To adjust the ringer volume of the telephone base:

When the telephone base is idle, press **+/VOLUME** or **-/VOLUME** on it to adjust the ringer volume.

Call waiting

1. When you hear a call waiting tone during a call, press **FLASH** on the cordless handset or the telephone base to put the current call on hold and take the new incoming call.
2. Press **FLASH** at any time to switch back and forth between calls.

Mute

To mute the microphone:

1. During a call, press **MUTE** on the cordless handset. The **MUTE** light turns on when the mute function is turned on. You can hear the party on the other end but they cannot hear you.
2. Press **MUTE** again to resume the conversation. The **MUTE** light turns off.

Message waiting indicator

When a voice message is received, the **MESSAGE WAITING** LEDs on the telephone base and handset flash.

Hold

To place a call on hold on the cordless handset:

1. During a call, press **HOLD** on the cordless handset. The **TALK** key on the cordless handset and the **LINE** key on the telephone base flash when the call is on hold.
2. Press **TALK** or **☎/SPEAKER** to release the call from hold, or the call will end automatically after the preset call on hold duration.

To place a call on hold on the telephone base:

1. During a call, press **HOLD** on the telephone base. The **TALK** key on the cordless handset and the **LINE** key on the telephone base flash when the call is on hold.
2. Press **LINE** **☎/SPEAKER** to release the call from hold, or the call will end automatically after the preset call on hold duration.

Intercom (for S2410 only)

Use this feature for conversations between two cordless handsets, or a cordless handset and the telephone base.

To initiate an intercom call:

- On the cordless handset, press **INTERCOM** when it is not in use. It beeps and the **INTERCOM** key flashes. All destination cordless handsets and the telephone base ring. The **INTERCOM** keys on other cordless handsets and **INT** key on the telephone base flash.

-OR-

- On the telephone base, press **INT** when it is not in use. It beeps and the **INT** key flashes. All destination cordless handsets ring and the **INTERCOM** keys flash.

To initiate an intercom call during a call:

- During a call on the cordless handset, press **HOLD** to put the current call on hold. Then press **INTERCOM**. It beeps and the **INTERCOM** key illuminates. All destination cordless handsets and the telephone base ring. The **INTERCOM** keys on other cordless handsets and **INT** key on the telephone base flash.

-OR-

- During a call on the telephone base, press **HOLD** to put the current call on hold. Then press **INT**. It beeps and the **INT** key illuminates. All destination cordless handsets ring and the **INTERCOM** keys flash.

Telephone operation

SIP contemporary cordless 1-line - S2410/CTM-S2411

To answer an intercom call:

- Lift the cordless handset from the telephone base, charging base or charging stand, or press **INTERCOM** on the cordless handset when it is not cradled on the telephone base, charging base or charging stand.

-OR-

- Press **INT** or /SPEAKER on the telephone base.

To answer an incoming call during an intercom call:

Press **TALK** on the cordless handset or press /SPEAKER twice on the telephone base. The intercom call ends automatically.

To end an intercom call:

- Press **OFF** or place the handset back in its charging base.

-OR-

- Press **INT** or /SPEAKER on the telephone base.

Find handset

Use this feature to find all registered cordless handsets.

To start paging:

Press /FIND HANDSET on the telephone base when the phone is not in use. All idle cordless handsets beep for 60 seconds.

To end paging:

- Press /FIND HANDSET again on the telephone base.

-OR-

- Press any key on the cordless handset to stop the paging tone.

Computer port

You can route your computer through the **COMPUTER** port (RJ-45) on the side of the telephone base to get Internet access.

USB port

The  port on the side of the telephone base can be used for charging devices (up to 500mA @ 5V). Charging will be suspended when there is an incoming call or the telephone is in use.

Telephone operation

SIP contemporary cordless 1-line accessory Petite - CTM-S241P

Receive a call

When there is an incoming call, the telephone rings. The **IN USE** LED flashes.

To answer a call:

Lift the corded handset from the accessory Petite phone base. The **IN USE** LED illuminates.

Place a call

Lift the corded handset. Listen for a dial tone and then dial the desired number, or press a Speed Dial key to dial a programmed number. The **IN USE** LED illuminates.

End a call

Place the corded handset in the phone cradle.

Switch a call between the accessory Petite and the telephone base speakerphone

- To switch a call from the accessory Petite to the telephone base speakerphone, press **◀/SPEAKER** on the telephone base.
- To switch a call from the telephone base speakerphone to the accessory Petite, lift the corded handset from the accessory Petite phone base.

Share a call

A maximum of four cordless handsets or accessory Petite phones can be used at the same time on an external call.

To join a call:

During a call, lift the corded handset to join.

Volume

Listening volume and ringer volume can be adjusted from the accessory Petite phone base.

To adjust the listening volume:

During a call, press **+/VOLUME** or **-/VOLUME** to adjust the listening volume. The next call returns to the default listening volume.

To adjust the ringer volume:

At any time, slide the **RINGER VOL** switch on the right side of the accessory Petite phone base to adjust the ringer volume.

Call waiting

1. When you hear a call waiting tone during a call, press **FLASH** on the accessory Petite phone base to put your current call on hold and take the new incoming call.
2. Press **FLASH** or the switch hook once rapidly at any time to switch back and forth between calls.

Mute

To mute the microphone:

1. During a call, press **MUTE** on the accessory Petite. The **MUTE** key illuminates when the mute function is turned on. You can hear the party on the other end but they cannot hear you.
2. Press **MUTE** again to resume the conversation. The light on the **MUTE** key turns off.

Hold

When a call is placed on hold, any parallel phone that tries to use the same phone line will take the call off hold and pick the call.

To place a call on hold:

1. During a call, press **HOLD** on the accessory Petite phone base to place that call on hold. The **IN USE** LED flashes when the call is placed on hold.
2. To release the call from hold, press the switch hook once rapidly.

USB port

The  port on the side of the accessory Petite can be used for charging devices (up to 1A @ 5.1V).

Telephone operation

SIP contemporary cordless 2-line - S2420/CTM-S2421

Using the cordless handset and the telephone base

The cordless handset and the telephone base cannot be used on the same call. However, calls can be switched between the cordless handset and the telephone base speakerphone.

When the cordless handset or the telephone base is in use, the corresponding line keys on the cordless handset and the telephone base illuminate.

Receive a call

When there is an incoming call, the telephone rings. The corresponding line key and the **MESSAGE WAITING** LED on the telephone base flash, and the corresponding line key on the cordless handset flashes.

To answer a call using the cordless handset while it is not on the telephone base, charging base or charging stand:

On the cordless handset, press the flashing line key for the ringing line, or press **☎/SPEAKER**. It automatically connects to the ringing line. The respective line key illuminates when the phone line is in use. The **☎/SPEAKER** key illuminates when in speakerphone mode.

To answer a call using the cordless handset while it is resting on the telephone base, charging base or charging stand:

Pick up the cordless handset from the telephone base. It automatically connects to the ringing line. The respective line key illuminates when the phone line is in use.

To answer a call using the telephone base:

On the telephone base, press the flashing line key, or **☎/SPEAKER** to pick up the ringing line. The respective line key illuminates when the phone line is in use. The **☎/SPEAKER** key illuminates when in speakerphone mode.

Place a call

To place a call using the cordless handset:

On the cordless handset, press **LINE 1**, **LINE 2** or **☎/SPEAKER**. Listen for a dial tone and then dial the desired number. The respective line key illuminates when the phone line is in use. The **☎/SPEAKER** key illuminates when in speakerphone mode.

To place a call using the telephone base:

On the telephone base, press **LINE 1**, **LINE 2** or **☎/SPEAKER**. Listen for a dial tone and then dial the desired number, or press a Speed Dial key to dial a programmed number. The line key illuminates when the phone line is in use. The **☎/SPEAKER** key illuminates when in speakerphone mode.

End a call

To end a call when using the cordless handset:

Press **OFF** on the cordless handset or place it in the telephone base, charging base or charging stand. The call ends when all handsets hang up.

To end a call when using the telephone base:

Press **☎/SPEAKER** or the respective line key on the telephone base.

Switch a call between the cordless handset and the telephone base speakerphone

- To switch a call from the cordless handset to the telephone base speakerphone, press the respective line key or **☎/SPEAKER** on the telephone base.
- To switch a call from the telephone base speakerphone to the cordless handset which is not on the telephone base cradle, press the respective line key or **☎/SPEAKER** on the cordless handset.
- To switch a call from the telephone base speakerphone to the cordless handset which is cradled on the telephone base, lift the cordless handset from the telephone base.

Share a call

During a call on line 1 or line 2, press the respective line key or **☎/SPEAKER**.

Handset speakerphone

During a call on the handset, press **☎/SPEAKER** on the cordless handset to switch between speakerphone mode and handset earpiece mode.

Speakerphone

When the telephone is idle, press **☎/SPEAKER** on the cordless handset or the telephone base. The first available line is selected, starting with line 1.

Telephone operation

SIP contemporary cordless 2-line - S2420/CTM-S2421

Redial

The last dialed number on the cordless handset or the telephone base is stored for 15 minutes.

To redial the last dialed number:

Press **LINE 1**, **LINE 2** or **☎/SPEAKER**. Listen for a dial tone. Then press **REDIAL**.

Volume

Listening volume can be adjusted on the cordless handset and the telephone base.

To adjust the listening volume:

- During a call on the handset, press **-/VOLUME/+** on it to adjust the listening volume. The next call returns to the default listening volume.
- During a call on the telephone base, press **+/VOLUME** or **-/VOLUME** on it to adjust the listening volume. The next call returns to the default listening volume.

Ringer volume of the telephone base can be adjusted.

To adjust the ringer volume of the telephone base:

When the telephone base is idle, press **+/VOLUME** or **-/VOLUME** on it to adjust the ringer volume.

Call waiting

Call waiting supports 2-line phones configured as single SIP account only. To change the SIP account settings, refer to the **SIP Phone Configuration Guide** for details.

1. When you hear a call waiting tone during a call, press the corresponding line key to put the current call on hold and take the new incoming call.
2. Press the corresponding line key at any time to switch back and forth between calls.

Message waiting indicator (only for line 1)

When a voice message is received, the **MESSAGE WAITING** LEDs on the telephone base and handset flash.

Mute

To mute the microphone:

1. During a call, press **MUTE** on the cordless handset or the telephone base. The **MUTE** lights turns on when the mute function is turned on. You can hear the party on the other end but they cannot hear you.
2. Press **MUTE** again to resume the conversation. The **MUTE** light turns off.

Hold

1. During a call, press **HOLD** on the cordless handset or the telephone base to place that call on hold. The corresponding line key flashes when the call is on hold.
2. Press the flashing line key or **☎/SPEAKER** to release the call from hold, or the call will end automatically after the preset call on hold duration. When both lines are on hold, press **☎/SPEAKER** only releases the call from hold on line 1.

Intercom (for S2420 only)

Use this feature for conversations between two cordless handsets, or a cordless handset and the telephone base.

To initiate an intercom call:

- On the cordless handset, press **INTERCOM** when it is not in use. It beeps and the **INTERCOM** key illuminates. All destination cordless handsets and the telephone base ring. The **INTERCOM** keys on other cordless handsets and **INT** key on the telephone base flash.

-OR-

- On the telephone base, press **INT** when it is not in use. It beeps and the **INT** key illuminates. All destination cordless handsets ring and the **INTERCOM** keys flash.

To initiate an intercom call during a call:

- During a call on the cordless handset, press **HOLD** to put the current call on hold. Then press **INTERCOM**. It beeps and the **INTERCOM** key illuminates. All destination cordless handsets and the telephone base ring. The **INTERCOM** keys on other cordless handsets and **INT** key on the telephone base flash.

-OR-

- During a call on the telephone base, press **HOLD** to put the current call on hold. Then press **INT**. It beeps and the **INT** key illuminates. All destination cordless handsets ring and the **INTERCOM** keys flash.

Telephone operation

SIP contemporary cordless 2-line - S2420/CTM-S2421

To answer an intercom call:

- Lift the cordless handset from the telephone base, charging base or charging stand, or press **INTERCOM** on the cordless handset when it is not cradled on the telephone base, charging base or charging stand.

-OR-

- Press **INT** or /SPEAKER on the telephone base.

To answer an incoming call during an intercom call:

Press the flashing line key on the cordless handset or the telephone base, or press /SPEAKER twice on the telephone base. The intercom call ends automatically.

To end an intercom call:

- Press **OFF** or place the handset back in its charging base.

-OR-

- Press **INT** or /SPEAKER on the telephone base.

Conference call

This telephone allows three-way conversations.

To initiate a conference call:

1. Place a call to the first party.
2. Press **HOLD** to place the first party on hold.
3. Place a second call on the other line.
4. Once the second party is on the line, press **CONF** to start a three-way conference.

To initiate a conference call while both calls are on hold:

Press **CONF** to start a three-way conference.

To switch a conference call from the telephone base to the cordless handset:

- During a conference call on the telephone base, press /SPEAKER or **CONF** on the cordless handset.
- During a conference call on the telephone base, press **HOLD** on the telephone base and then press **CONF** on the cordless handset.

To switch a conference call from the cordless handset to the telephone base:

- During a conference call on the cordless handset, press /SPEAKER or **CONF** on the telephone base.
- During a conference call on the cordless handset, press **HOLD** on the cordless handset and then press **CONF** on the telephone base.

To end a conference call:

- When the conference call is at the telephone base, press /SPEAKER or **CONF** on the telephone base.
- When the conference call is on the cordless handset, press **OFF** on the cordless handset, or place it back in the telephone base, charging base or charging stand.
- When there is more than one cordless handset on the conference call, the call ends when all handsets hang up.

Find handset

Use this feature to find all registered cordless handsets.

To start paging:

Press /FIND HANDSET on the telephone base when the phone is not in use. All idle cordless handsets beep for 60 seconds.

To end paging:

- Press /FIND HANDSET again on the telephone base.

-OR-

- Press any key on the handset to stop the paging tone.

Computer port

You can route your computer through the **COMPUTER** port (RJ-45) on the side of the telephone base to get Internet access.

USB port

The  port on the side of the telephone base can be used for charging devices (up to 500mA @ 5V). Charging will be suspended when there is an incoming call or the telephone is in use.

Telephone operation

SIP contemporary cordless 2-line accessory Petite - CTM-S242P

Receive a call

- When there is a line 1 incoming call, the telephone rings. The **LINE 1** key flashes.
- When there is a line 2 incoming call, the telephone rings. The **LINE 2** key flashes.

To answer a call:

Lift the corded handset. It automatically connects to the ringing line. The respective line key illuminates when in use.

Place a call

Lift the corded handset then press **LINE 1** or **LINE 2**. Listen for a dial tone and then dial the desired number, or press a Speed Dial key to dial a programmed number. The respective line key illuminates when in use.

End a call

Place the corded handset in the phone cradle.

Switch a call between the accessory Petite and the telephone base speakerphone

- To switch a call from the accessory Petite to the telephone base speakerphone, press **SPEAKER** on the telephone base.
- To switch a call from the telephone base speakerphone to the accessory Petite, lift the corded handset from the accessory Petite phone base.

Share a call

A maximum of four cordless handsets or accessory Petite phones can be used at the same time on an external call.

To join a call:

During a call on line 1 or line 2, press the respective **LINE 1** or **LINE 2** key to join.

Volume

Listening volume and ringer volume can be adjusted from the accessory Petite phone base.

To adjust the listening volume:

During a call, press **+VOLUME** or **-VOLUME** to adjust the listening volume. The next call returns to the default listening volume.

To adjust the ringer volume:

At any time, slide the **RINGER VOL** switch on the right side of the accessory Petite phone base to adjust the ringer volume.

Call waiting

1. When you hear a call waiting tone during a call, press **FLASH** on the accessory Petite phone base to put your current call on hold and take the new incoming call.
2. Press **FLASH** or the switch hook once rapidly at any time to switch back and forth between calls.

Mute

To mute the microphone:

1. During a call, press **MUTE** on the accessory Petite phone base. The **MUTE** key illuminates when the mute function is turned on. You can hear the party on the other end but they cannot hear you.
2. Press **MUTE** again to resume the conversation. The light on the **MUTE** key turns off.

Hold

When a call is placed on hold, any parallel phone that tries to use the same phone line will take the call off hold and pick the call.

To place a call on hold:

1. During a call, press **HOLD** on the accessory Petite phone base to place that call on hold. The respective line key flashes when the call is placed on hold.
2. Press the flashing line key to release the call from hold. The respective line key illuminates when in use.

Telephone operation

SIP contemporary cordless 2-line accessory Petite- CTM-S242P

Conference call

This telephone allows three-way conversations.

To initiate a conference call:

1. Place a call to the first party.
2. Press **HOLD** to place the first party on hold.
3. Place a second call on the other line.
4. Once the second party is on the line, press **CONF** to start a three-way conference.

To initiate a conference call while both calls are on hold:

Press **CONF** to start a three-way conference.

To end a conference call:

- Place the corded handset back in the accessory phone base to end.
- When there is more than one phone devices on the conference call, the call ends when all phone devices hang up.

USB port

The  port on the side of the accessory Petite can be used for charging devices (up to 1A @ 5.1V).

Appendix

Troubleshooting

If you have difficulty with the telephones, please try the suggestions below. For customer service, visit our website at www.vtechhotphones.com or call 1-888-907-2007.

The telephone does not work at all.

- Make sure the Cat-5 network cable is plugged into the **LAN** port of the telephone base and the network wall jack with Power over Ethernet (PoE).
- Make sure the battery is installed and charged correctly (pages 33, 36, 44, 46, 53 and 55). For optimum daily performance, return the cordless handset to the telephone base, charging base or charging stand after use.
- Unplug the Cat-5 network cable from the network wall jack. Wait for approximately 15 seconds, then plug it back in.
- Charge the battery in the cordless handset for up to 16 hours.
- If the battery is completely depleted, charge the battery for at least 30 minutes before use.
- Remove the battery and then install it again. If that still does not work, it may be necessary to purchase a new battery.
- Disconnect the telephone base from the network wall jack and connect a different working SIP telephone. If the other SIP telephone does not work, the problem is probably in the wiring or network server. Check your SIP server settings. Refer to the **SIP Phone Configuration Guide** for details.
- Make sure the energy-saving charging mode is not activated. If this mode is activated, all telephone functions will be disabled, except battery charging (page 84).

There is no dial tone.

- Try all the above suggestions.
- The Cat-5 network cable may be defective. Install a new Cat-5 network cable.
- Make sure your network is providing Power over Ethernet (PoE).
- Disconnect the telephone base from the network wall jack and connect a different working SIP telephone. If there is no dial tone on this telephone either, the problem is in your wiring or network server. Check your SIP server settings and refer to the **SIP Phone Configuration Guide** for details.
- Make sure the initialization and system registration process completes (pages 32 and 42). The speakerphone key blinks twice every second if there are errors with the initialization and system registration process. Check your SIP server settings. Refer to the **SIP Phone Configuration Guide** for details.
- Make sure the energy-saving charging mode is not activated. If this mode is activated, all telephone functions will be disabled, except battery charging (page 84).

I cannot dial out.

- Try all the above suggestions.
- Make sure there is a dial tone before dialing. It is normal if the cordless handset takes a second or two to synchronize with the telephone base before producing a dial tone. Wait an extra second before dialing.
- A prefix may be required for dialing some internal or external calls. Refer to the **SIP Phone Configuration Guide** for details.
- Check your SIP server settings. If other SIP telephones in your hotel are having the same problem, the problem is in the wiring or network server. Contact your telephone service provider (charges may apply).

The Speed Dial key does not work at all.

- The Speed Dial key may not be properly programmed. Refer to the **SIP Phone Configuration Guide** for details.

The telephone does not store the last number dialed.

- For security, the last number dialed in the **REDIAL** memory will be automatically cleared after 15 minutes.

The telephone cannot register to the SIP network server.

- Make sure your network is providing Power over Ethernet (PoE).
- Make sure the initialization and system registration process completes (pages 32 and 42).
- If there is an error during the initialization and system registration process, the **(M)/SPEAKER** key flashes twice every second. Disconnect the Cat-5 network cable from the network wall jack and connect it back into the network wall jack with Power over Ethernet (PoE) to start the initialization and system registration process again.

The LOW BATTERY LED illuminates on the cordless handset.

- Place the cordless handset in the telephone base, charging base or charging stand for recharging.
- Remove the battery and then install it again. Use it until fully depleted, then charge the cordless handset in the telephone base, charging base or charging stand for up to 16 hours.
- If the above measures do not correct the problem, replace the battery.

Appendix

Troubleshooting

The battery does not charge in the cordless handset or the battery does not accept charge.

- Make sure the cordless handset is placed in the telephone base, charging base or charging stand correctly. The **CHARGE LED** should be on.
- Remove the battery and then install it again. Then charge for up to 16 hours.
- If the cordless handset is in the telephone base, charging base or charging stand but the **CHARGE LED** is not on, refer to **The CHARGE LED is off** below.
- If the battery is completely depleted, charge the cordless handset for at least 30 minutes before use.
- If the above measures do not correct the problem, replace the battery.

The CHARGE LED is off.

- Clean the charging contacts on the cordless handset, telephone base, charging base and/or charging stand each month with a pencil eraser or a dry non-abrasive fabric.
- Make sure the Cat-5 network cable is plugged in correctly and securely.
- Unplug the Cat-5 network cable. Wait for 15 seconds before plugging it back in.

The telephone does not ring when there is an incoming call.

- Make sure the Cat-5 network cable is plugged into the **LAN** port of the telephone base and the network wall jack with Power over Ethernet (PoE).
- The cordless handset may be too far from the telephone base. Move it closer to the telephone base.
- Check your SIP server or telephone administrative settings. Refer to the **SIP Phone Configuration Guide** for details.
- If other SIP telephone in your hotel are having the same problem, the problem is in the wiring or network server. Contact your telephone service provider (charges may apply).
- Other electronic products such as HAM radios and other DECT phones can cause interference with your cordless phone. Try installing your phone as far away as possible from these types of electronic devices.
- The Cat-5 network cable may be defective. Install a new Cat-5 network cable.
- Remove the battery and then install it again. Then place the cordless handset in the telephone base. Wait for the handset to synchronize with the telephone base. Allow up to one minute for this to take place.

The cordless handset beeps and is not performing normally.

- Make sure the Cat-5 network cable is plugged into the **LAN** port of the telephone base and the network wall jack with Power over Ethernet (PoE).
- Check your SIP server or telephone administrative settings. Refer to the **SIP Phone Configuration Guide** for details.
- Disconnect the telephone base from the network wall jack and connect a different working SIP telephone. If the other SIP telephone has the same problem, the problem is in the wiring or network server. Contact your telephone service provider (charges may apply).
- Other electronic products such as HAM radios and other DECT phones can cause interference with your cordless phone. Try installing your phone as far away as possible from these types of electronic devices.

There is interference during a telephone conversation, or the call fades in and out when I am using the cordless handset.

- The cordless handset may be out of range. Move the handset closer to the telephone base or adjust the setting of RF transmission power. Refer **SIP Phone Configuration Guide** for details.
- Other electronic products such as HAM radios and other DECT phones can cause interference with your cordless phone. Try installing your phone as far away as possible from these types of electronic devices.
- If other SIP telephones in your hotel are having the same problem, the problem is in the wiring or network server. Contact your telephone service provider (charges may apply).

I hear other calls when using the telephone.

- Disconnect the telephone base from the network wall jack and connect a different working SIP telephone. Check your SIP server settings. If calls are still not clear, the problem is probably in the wiring or network server. Contact your telephone service provider (charges may apply).

I hear noise on the cordless handset and the keys do not work.

- Make sure the Cat-5 network cable is plugged in correctly and securely.
- Unplug the Cat-5 network cable. Wait for 15 seconds before plugging it back in.

Appendix

Precautions for users of implanted cardiac pacemakers

Cardiac pacemakers (applies only to digital cordless telephones):

Wireless Technology Research, LLC (WTR), an independent research entity, led a multidisciplinary evaluation of the interference between portable wireless telephones and implanted cardiac pacemakers. Supported by the U.S. Food and Drug Administration, WTR recommends to physicians that:

Pacemaker patients

- Should keep wireless telephones at least six inches from the pacemaker.
- Should NOT place wireless telephones directly over the pacemaker, such as in a breast pocket, when it is turned ON.
- Should use the wireless telephone at the ear opposite the pacemaker.

WTR's evaluation did not identify any risk to bystanders with pacemakers from other persons using wireless telephones.

Operating range

The cordless telephone operates with the maximum power allowed by the Federal Communications Commission (FCC). Even so, the cordless handset and telephone base can communicate over only a certain distance - which can vary with the locations of the telephone base, cordless handset, the weather, and the layout of the hotel.

When the cordless handset is out of range while on a call, the cordless handset rapidly beeps three times.

If there is a call while the handset is out of range, it may not ring, or if it does ring, the call may not connect well when you answer the call. Move closer to the telephone base to answer the call.

If the handset moves out of range during a telephone conversation, there may be interference.

To improve reception, move closer to the telephone base.

About cordless telephones

- **Privacy:** The same features that make a cordless telephone convenient create some limitations. Telephone calls are transmitted between the telephone base and the cordless handset by radio waves, so there is a possibility that the cordless telephone conversations could be intercepted by radio receiving equipment within range of the cordless handset. For this reason, you should not think of cordless telephone conversations as being as private as those on corded telephones.
- **Network wall jack:** The telephone base of the cordless telephone must be connected to a working network wall jack with Power over Ethernet (PoE). Calls cannot be made from the cordless handset if the telephone base is unplugged or switched off.
- **Potential TV interference:** Some cordless telephones operate at frequencies that may cause interference to televisions and VCRs. To minimize or prevent such interference, do not place the telephone base of the cordless telephone near or on top of a TV or VCR. If interference is experienced, moving the cordless telephone farther away from the TV or VCR often reduces or eliminates the interference.
- **Rechargeable batteries:** Exercise care in handling batteries in order not to create a short circuit with conducting material such as rings, bracelets and keys. The battery or conductor may overheat and cause harm. Observe proper polarity between the battery and the battery charger.
- **Nickel-metal hydride rechargeable batteries:** Dispose of these batteries in a safe manner. Do not burn or puncture the battery. Like other batteries of this type, if burned or punctured, they could release caustic material which could cause injury.

The RBRC® seal



The RBRC® seal on the nickel-metal hydride battery indicates that VTech Communications, Inc. is voluntarily participating in an industry program to collect and recycle these batteries at the end of their useful lives, when taken out of service within the United States and Canada.

The RBRC® program provides a convenient alternative to placing used nickel-metal hydride batteries into the trash or municipal waste, which may be illegal in your area.

VTech's participation in RBRC® makes it easy for you to drop off the spent battery at local retailers participating in the RBRC® program or at authorized VTech product service centers. Please call **1 (800) 8 BATTERY™** for information on Ni-MH battery recycling and disposal bans/restrictions in your area. VTech's involvement in this program is part of its commitment to protecting our environment and conserving natural resources.

RBRC® is a registered trademark of Rechargeable Battery Recycling Corporation.

Appendix

VTech Hospitality limited warranty program

VTech Communications, Inc., the manufacturer of VTech Hospitality Product ("Product"), warrants to the holder of a valid proof of purchase ("end user" or "you") that the Product and all accessories provided by VTech in the Product's package are free from defects in material and workmanship, pursuant to the following terms and conditions, when installed and used normally and in accordance with the Product's operating instructions. The limited warranty extends to the end user of this Product and applies only if such Product is purchased through a United States of America and/or Canadian distributor. The limited warranty period for this Product is determined based on the following:

5 Years – Analog Models

- All Classic Models – corded and cordless
- All Contemporary Models – corded and cordless
- All TrimStyle Models

2 Years – SIP Non-Display Models

- All Classic Models – corded and cordless
- All Contemporary Models – corded and cordless
- All TrimStyle Models

During the limited warranty period, VTech's authorized service representative will repair or replace, at VTech's option, without charge, a Product that is not free from defects in materials and workmanship. If VTech's authorized service representative repairs the Product, new or refurbished replacement parts may be used. If the Product is replaced, it may be replaced with a new or refurbished Product of the same or similar design. Repair or replacement of Product, at VTech's option, is the exclusive remedy.

The limited warranty period for the Product begins on the date that the end user takes possession of the Product. This limited warranty also applies to repaired or replacement Products for a period of either: (a) 90 days from the date the repaired or replacement Product is shipped to you; or (b) the time remaining on the original limited warranty as described above; whichever is longer.

This limited warranty does not cover:

1. Product or parts that have been subjected to misuse, accident, shipping or other physical damage, improper installation, abnormal operation or handling, neglect, inundation, fire, water or other liquid intrusion; or
2. Product that has been damaged due to repair, alteration or modification by anyone other than an authorized service representative of VTech; or
3. Product to the extent that the problem experienced is caused by signal conditions, network reliability or cable or antenna systems; or
4. Product to the extent that the problem is caused by use with non-VTech accessories; or
5. Product whose warranty/quality stickers, product serial number plates or electronic serial numbers have been removed, altered or rendered illegible; or
6. Product purchased, used, serviced, or shipped for repair from outside the United States or Canada, or used for non-approved commercial or institutional purposes (including but not limited to Products used for rental purposes); or
7. Product returned without valid proof of purchase; or
8. Charges or costs incurred by the end user, and risk of loss or damage, in removing and shipping the Product, or for installation or set up, adjustment of customer controls, and installation or repair of systems outside the unit.
9. Line cords or coil cords, plastic overlays, connectors, power adapters and batteries, if the Product is returned without them. VTech will charge the end user at then-current prices for each of the missing items.
10. NiCd or NiMH handset batteries, or power adapters, which, under all circumstances, are covered by a one (1) year warranty only.

Except as provided by applicable law, you assume the risk of loss or damage during transit and transportation and are responsible for delivery or handling charges incurred in the transport of Product(s) to the service location. VTech's authorized service representative will return repaired or replaced product under this limited warranty to you, transportation, delivery and handling charges prepaid. VTech assumes no risk for damage or loss of the Product in transit.

If the Product failure is not covered by this limited warranty, or proof of purchase does not meet the terms of this limited warranty, VTech will notify you and will request that you authorize the cost of repair and return shipping costs for the repair of Products that not covered by this limited warranty. You must pay for the cost of repair and return shipping costs for the repair of Products that are not covered by this limited warranty.

Other limitations

This warranty is the complete and exclusive agreement between you and VTech. It supersedes all other written or oral communications related to this Product. VTech provides no other warranties for this Product, whether express or implied, oral or written, or statutory. The warranty exclusively describes all of VTech's responsibilities regarding the Product. No one is authorized to make modifications to this warranty and you should not rely on any such modification.

VTech's liability to end user hereunder shall not exceed the purchase price of the Product. In no event shall VTech be liable for any indirect, special, incidental, consequential, or similar damages (including, but not limited to lost profits or revenue, inability to use the product, or other associated equipment, the cost of substitute equipment, and claims by third parties) resulting from the use of this Product. Some states/provinces do not allow the exclusion or limitation of incidental or consequential damages, so the above limitation or exclusion may not apply to you.

This warranty gives you specific legal rights, and you also have other rights which vary from state to state or province to province.

Appendix

FCC, ACTA and IC regulations

FCC Part 15

This equipment has been tested and found to comply with the limits for a Class A digital device, pursuant to Part 15 of the FCC Rules. These limits are designed to provide reasonable protection against harmful interference when the equipment is operated in a commercial environment. This equipment generates, uses and can radiate radio frequency energy and, if not installed and used in accordance with the instruction manual, may cause harmful interference to radio communications. Operation of this equipment in a residential area is likely to cause harmful interference in which case the user will be required to correct the interference at his own expense.

Changes or modifications to this equipment not expressly approved by the party responsible for compliance could void the user's authority to operate the equipment.

This device complies with Part 15 of the FCC rules. Operation is subject to the following two conditions: (1) this device may not cause harmful interference, and (2) this device must accept any interference received, including interference that may cause undesired operation.

For cordless telephone only - Privacy of communications may not be ensured when using this telephone.

For cordless telephone only - To ensure safety of users, the FCC has established criteria for the amount of radio frequency energy that can be safely absorbed by a user or bystander according to the intended usage of the product. This product has been tested and found to comply with the FCC criteria. The handset may be safely held against the ear of the user. The telephone base shall be installed and used such that parts of the user's body other than the hands are maintained at a distance of approximately 20 cm (8 inches) or more.

This Class A digital apparatus complies with Canadian ICES-003.

Industry Canada

Operation is subject to the following two conditions: (1) this device may not cause harmful interference, and (2) this device must accept any interference, including interference that may cause undesired operation.

The term "IC:" before the certification/registration number only signifies that the Industry Canada technical specifications were met.

This product meets the applicable Industry Canada technical specifications.

Appendix

Energy-saving charging mode

When this mode is activated, all telephone functions, except handset battery charging, will be disabled.

To activate the energy-saving charging mode in the S2410/S2420/CTM-S2411/CTM-S2421 handset which is cradled on the charging base (C4001) or charging stand (C4011):

- When a registered cordless handset is idle, press ***331734#** and then press **HOLD**. You hear 3 rising beeps. Then put this handset into the charger.

To deactivate the energy-saving charging mode:

- Register your handsets back to the corresponding telephone base. See page 45 or 47 for handset registration instructions.

To activate the energy-saving charging mode in S2410/S2420/CTM-S2411/CTM-S2421 telephone base:

1. Remove the faceplate and overlay if they are on the telephone base.
2. When you see the slide switch inside the left hole, use a sharp object, such as a paper clip, to slide it to the right side.

To deactivate the energy-saving charging mode:

1. Remove the faceplate and overlay if they are on the telephone base.
2. When you see the slide switch inside the left hole, use a sharp object, such as a paper clip, to slide it to the left side.

To activate the energy-saving charging mode in the cordless handset (C4400/C4500/CTM-C4401/CTM-C4501), charging base (C4001) and charging stand (C4011):

- When a registered cordless handset is idle, press ***331734#** and then press **HOLD**. You hear 3 rising beeps. Then put this handset into the charger.

To deactivate the energy-saving charging mode:

- Register your handsets back to the corresponding telephone base. See page 54 or 56 for handset registration instructions.

To activate the energy-saving charging mode in the charging base C4300 and the charging stand C4310:

- Slide the slide switch to the right side.

To deactivate the energy-saving charging mode:

- Slide the slide switch to the left side.

Maintenance

Taking care of your telephone

Your telephone contains sophisticated electronic parts, so it must be treated with care.

Avoid rough treatment

Place the handset down gently. Save the original packing materials to protect your telephone if you ever need to ship it.

Avoid water

Your telephone can be damaged if it gets wet. Do not use the handset outdoors in the rain, or handle it with wet hands. Do not install the telephone base near a sink, bathtub or shower.

Electrical storms

Electrical storms can sometimes cause power surges harmful to electronic equipment. For your own safety, take caution when using electrical appliances during storms.

Cleaning your telephone

Your telephone has a durable plastic casing that should retain its luster for many years. Clean it only with a soft cloth slightly dampened with water or mild soap. Do not use excess water or cleaning solvents of any kind.

Remember that electrical appliances can cause serious injury if used when you are wet or standing in the water. If the telephone base should fall into the water, **DO NOT RETRIEVE IT UNTIL YOU UNPLUG THE NETWORK CABLE FROM THE WALL**. Then remove the telephone by the unplugged cords.

Appendix

Technical specifications

SIP classic trimstyle 1-line/2-line - S1310/S1320

Power requirement	PoE class 2 powered (48V)
Frequency control	Crystal controlled PLL synthesizer
Transmit frequency	Handset: 1921.536-1928.448 MHz
Channels	5
Nominal effective range	Maximum power allowed by FCC and IC. Actual operating range may vary according to environmental conditions at the time of use.
Message waiting signal	From SIP server
Size	Telephone base: 8.82 x 2.84 x 1.54 in (224 x 72 x 39 mm) Corded handset: 2.23 x 2.15 (0.99) x 8.24 in (56.74 x 54.56 (25.26) x 209.40 mm)

SIP classic cordless 1-line/2-line - S1410/S1420

Power requirement	Telephone base: PoE class 2 powered (48V) Handset: 2.4V Ni-MH battery
Frequency control	Crystal controlled PLL synthesizer
Transmit frequency	Handset: 1921.536-1928.448 MHz Telephone base: 1921.536-1928.448 MHz
Channels	5
Nominal effective range	Maximum power allowed by FCC and IC. Actual operating range may vary according to environmental conditions at the time of use.
Computer-Interface	1 x 10/100 Mbps RJ-45 port
LAN-Interface	1 x 10/100 Mbps RJ-45 port
Message waiting signal	From SIP server
Speed Dial memory	Telephone base: up to 10 memory locations; up to 32 digits
Size	Telephone base: 8.66 x 6.02 x 2.56 in (220 x 153 x 65 mm) Handset: 2.23 x 2.15 (0.99) x 8.24 in (56.74 x 54.56 (25.26) x 209.40 mm)

SIP classic charging base - C3300

Power requirement	PoE class 2 powered (48V)
Size	8.82 x 2.84 x 1.54 in (224 x 72 x 39 mm)

SIP classic cordless 1-line/2-line accessory handset - C3400/C3500

Power requirement	2.4V Ni-MH battery
Frequency control	Crystal controlled PLL synthesizer
Transmit frequency	1921.536-1928.448 MHz
Channels	5
Nominal effective range	Maximum power allowed by FCC and IC. Actual operating range may vary according to environmental conditions at the time of use.
Message waiting signal	From SIP server
Size	2.23 x 2.15 (0.99) x 8.24 in (56.74 x 54.56 (25.26) x 209.40 mm)

Appendix

Technical specifications

SIP contemporary trimstyle 1-line/2-line - S2310/S2320

Power requirement	PoE class 2 powered (48V)
Frequency control	Crystal controlled PLL synthesizer
Transmit frequency	Handset: 1921.536-1928.448 MHz
Channels	5
Nominal effective range	Maximum power allowed by FCC and IC. Actual operating range may vary according to environmental conditions at the time of use.
Message waiting signal	From SIP server
Size	Telephone base: 8.11 x 3.70 x 2.87 in (206 x 94 x 73 mm) Corded handset: 8.39 x 1.89 x 1.65 in (213 x 48 x 42 mm)

SIP contemporary trimstyle 1-line/2-line - S2310-6VDC/S2320-6VDC

Power requirement	6V DC @ 450mA
Frequency control	Crystal controlled PLL synthesizer
Transmit frequency	Handset: 1921.536-1928.448 MHz
Channels	5
Nominal effective range	Maximum power allowed by FCC and IC. Actual operating range may vary according to environmental conditions at the time of use.
Message waiting signal	From SIP server
Size	Telephone base: 8.11 x 3.70 x 2.87 in (206 x 94 x 73 mm) Corded handset: 8.39 x 1.89 x 1.65 in (213 x 48 x 42 mm)

SIP contemporary cordless 1-line/2-line - S2410/S2420

Power requirement	Telephone base: PoE class 2 powered (48V) Handset: 2.4V Ni-MH battery
Frequency control	Crystal controlled PLL synthesizer
Transmit frequency	Handset: 1921.536-1928.448 MHz Telephone base: 1921.536-1928.448 MHz
Channels	5
Nominal effective range	Maximum power allowed by FCC and IC. Actual operating range may vary according to environmental conditions at the time of use.
Computer-Interface	1 x 10/100 Mbps RJ-45 port
LAN-Interface	1 x 10/100 Mbps RJ-45 port
Message waiting signal	From SIP server
Speed Dial memory	Telephone base: up to 10 memory locations; up to 32 digits
Size	Telephone base: 8.03 x 6.06 x 3.78 in (204 x 154 x 96 mm) Handset: 8.39 x 1.89 x 1.65 in (213 x 48 x 42 mm)

Appendix

Technical specifications

SIP contemporary cordless 1-line/2-line - CTM-S2411/CTM-S2421

Power requirement	2.4V Ni-MH battery
Frequency control	Crystal controlled PLL synthesizer
Transmit frequency	1921.536-1928.448 MHz
Channels	5
Nominal effective range	Maximum power allowed by FCC and IC. Actual operating range may vary according to environmental conditions at the time of use.
Message waiting signal	From SIP server
Speed Dial memory	Telephone base: up to 11 memory locations; up to 32 digits
Size	Telephone base: 8.03 x 6.06 x 3.78 in (204 x 154 x 96 mm) Handset: 8.39 x 1.89 x 1.65 in (213 x 48 x 42 mm)

SIP contemporary cordless 1-line/2-line accessory Petite - CTM-S241P/CTM-S242P

Frequency Control	Crystal controlled PLL synthesizer
Transmit frequency	1921.536-1928.448 MHz
Channels	5
Nominal effective range	Maximum power allowed by FCC and IC. Actual operating range may vary according to environmental conditions at the time of use.
Power requirement	5.1V DC @1.3 A
USB port	Provide charging current up to 1A
Speed Dial memory	Accessory Petite: up to 11 memory locations; up to 32 digits
Size	Accessory Petite: 8.03 x 6.06 x 3.78 in (204 x 154 x 96 mm) Corded handset: 8.39 x 1.89 x 1.65 in (213 x 48 x 42 mm)

SIP contemporary charging stand - C4011

Power requirement	6V DC @450mA
Size	3.78 x 2.80 x 4.29 in (96 x 71 x 109 mm)

SIP contemporary charging base - C4300

Power requirement	PoE class 2 powered (48V)
Size	8.11 x 3.70 x 2.87 in (206 x 94 x 73 mm)

SIP contemporary charging stand - C4310

Power requirement	PoE class 2 powered (48V)
Size	3.78 x 2.80 x 4.29 in (96 x 71 x 109 mm)

Appendix

Technical specifications

SIP contemporary cordless 1-line/2-line accessory handset - CTM-C4400/CTM-C4500

Power requirement	2.4V Ni-MH battery
Frequency control	Crystal controlled PLL synthesizer
Transmit frequency	1921.536-1928.448 MHz
Channels	5
Nominal effective range	Maximum power allowed by FCC and IC. Actual operating range may vary according to environmental conditions at the time of use.
Message waiting signal	From SIP server
Size	Telephone base: 8.03 x 6.06 x 3.78 in (204 x 154 x 96 mm) Handset: 8.39 x 1.89 x 1.65 in (213 x 48 x 42 mm)

SIP contemporary cordless 1-line/2-line accessory handset - CTM-C4401/CTM-C4501

Power requirement	2.4V Ni-MH battery
Frequency control	Crystal controlled PLL synthesizer
Transmit frequency	1921.536-1928.448 MHz
Channels	5
Nominal effective range	Maximum power allowed by FCC and IC. Actual operating range may vary according to environmental conditions at the time of use.
Message waiting signal	From SIP server
Speed Dial memory	Handset: up to 3 memory locations; up to 32 digits
Size	Telephone base: 8.03 x 6.06 x 3.78 in (204 x 154 x 96 mm) Handset: 8.39 x 1.89 x 1.65 in (213 x 48 x 42 mm)

SIP contemporary cordless 1-line/2-line accessory handset and charger bundle - CTM-S241HS/CTM-S242HS

Power requirement	Handset: 2.4V Ni-MH battery Charging stand: 6V DC @450mA
Frequency control	Crystal controlled PLL synthesizer
Transmit frequency	1921.536-1928.448 MHz
Channels	5
Nominal effective range	Maximum power allowed by FCC and IC. Actual operating range may vary according to environmental conditions at the time of use.
Message waiting signal	From SIP server
Size	Handset: 8.39 x 1.89 x 1.65 in (213 x 48 x 42 mm) Charging stand: 3.78 x 2.80 x 4.29 in (96 x 71 x 109 mm)

SIP contemporary cordless 1-line/2-line accessory handset with speed dials and charger bundle - CTM-S241SD/CTM-S242SD

Power requirement	Handset: 2.4V Ni-MH battery Charging stand: 6V DC @450mA
Frequency control	Crystal controlled PLL synthesizer
Transmit frequency	1921.536-1928.448 MHz
Channels	5
Nominal effective range	Maximum power allowed by FCC and IC. Actual operating range may vary according to environmental conditions at the time of use.
Message waiting signal	From SIP server
Speed Dial memory	Handset: up to 3 memory locations; up to 32 digits
Size	Handset: 8.39 x 1.89 x 1.65 in (213 x 48 x 42 mm) Charging stand: 3.78 x 2.80 x 4.29 in (96 x 71 x 109 mm)

Index

A

About cordless telephones 81
Answer a call 58, 59, 61, 63, 66, 68, 70, 73, 74, 77
Answer an intercom call 67, 69, 72, 76

C

C3300 8, 35
C3400 9, 36
C3500 10, 36
C4300 19, 51
C4310 20, 52
C4400 21, 53–54
C4500 23, 53–54
Call waiting 58, 59, 62, 64, 66, 68, 71, 73, 75, 77
Cardiac pacemakers 81
Charging 33, 36, 45, 47, 54, 56
Checklist 1–3
Computer port 62, 65, 72, 73, 76, 78
Conference call 60, 65, 69, 76, 78
CTM-C4401 22, 55–56
CTM-C4501 24, 55–56
CTM-S2411 14, 42–43, 46–47, 57, 70–72
CTM-S241HS 25, 53–54
CTM-S241P 15, 48–50, 57, 73
CTM-S241SD 27, 55–56
CTM-S2421 17, 42–43, 46–47, 57, 74–76
CTM-S242HS 26, 53–54
CTM-S242P 18, 48–50, 57, 77–78
CTM-S242SD 28, 55–56

D

Deregister an accessory Petite 50

E

End a call 58, 59, 61, 63, 66, 68, 70, 73, 74, 77
End a conference call 60, 65, 69, 76, 78
End an intercom call 67, 69, 72, 76

F

FCC, ACTA and IC regulations 83
Find handset 62, 65, 72, 76
Flash 58, 62, 66, 71, 73, 77

H

Handset battery charging 33, 36, 45, 47, 54, 56
Handset battery installation 33, 36, 44, 46, 53, 55
Handset registration 31, 33, 36, 41, 45, 47, 54, 56
Handset speakerphone 61, 63, 70, 74
Hold 58, 59, 62, 64, 66, 68, 71, 73, 75, 77

I

Important safety instructions i
Initialization and system registration 32, 42
Initiate a conference call 60, 65, 69, 76, 78
Initiate an intercom call 67, 69, 71, 75
Installation 29–56
Intercom 67, 69, 71, 75

J

Join a call 58, 59, 61, 63, 66, 68, 70, 73, 74, 77

L

Layout 4–28
Limited warranty 82
Listening volume 58, 59, 62, 64, 66, 68, 71, 73, 75, 77

M

Maintenance 84
Make a call 58, 59, 61, 63, 66, 68, 70, 73, 74, 77
Message waiting indicator 58, 59, 62, 64, 66, 68, 71, 75
Mute 58, 59, 62, 64, 66, 68, 71, 73, 75, 77

O

Operating range 81
Operation 58–78

P

Pacemaker patients 81
Paging handset 62, 65, 72, 76
Parts checklist 1–3
Place a call 58, 59, 61, 63, 66, 68, 70, 73, 74, 77
Precautions for users of implanted cardiac pacemakers 81

R

Range 81
Receive a call 58, 59, 61, 63, 66, 68, 70, 73, 74, 77
Redial 58, 59, 61, 64, 66, 68, 70, 75
Register a handset 31, 33, 36, 41, 45, 47, 54, 56
Register an accessory Petite 50
Replace a handset battery 33, 36, 44, 46, 53, 55
Ringer volume 62, 64, 71, 73, 75, 77

S

S1310 4, 29–31, 57, 58
S1320 5, 29–31, 57, 59–60
S1410 6, 32–34, 57, 61–62
S1420 7, 32–34, 57, 63–65
S2310 11, 37–38, 41, 57, 66–67
S2310-6VDC 11, 39–40, 41, 57, 66–67
S2320 12, 37–38, 41, 68–69
S2320-6VDC 12, 39–40, 41, 57, 68–69
S2410 13, 42–45, 57, 70–72
S2420 16, 42–45, 57, 74–76
Safety instructions i
Settings 57
Share a call 58, 59, 61, 63, 66, 68, 70, 73, 74, 77
Speakerphone 58, 59, 61, 63, 66, 68, 70, 73, 74, 77
Start a conference call 60, 65, 69, 76, 78
Switch a call 61, 63, 70, 73, 74, 77
Switch a conference call 65, 76

T

Technical specifications 85–88
Telephone installation 29–52
Telephone layout 4–28
Telephone operation 58–78
Telephone settings 57
Troubleshooting 79–80

U

USB port 62, 65, 72, 73, 76, 78
Users of implanted cardiac pacemakers 81

V

Volume 58, 59, 62, 64, 66, 68, 71, 73, 75, 77
VTech Hospitality limited warranty program 82

W

Wall mount 30, 34, 35, 38, 40, 43, 49, 51
Warranty 82

vtech[®]

VTECH TELECOMMUNICATIONS LTD.

A member of THE VTECH GROUP OF COMPANIES.

Distributed in the U.S.A. by VTech Communications, Inc., Beaverton, Oregon 97008.
Distributed in Canada by VTech Technologies Canada Ltd., Richmond, B.C. V6W 1L5.

VTech is the registered trademark of VTech Holdings Limited.

Petite™ Phone is a trademark of VTech Communications, Inc.

Copyright © 2013 for VTECH TELECOMMUNICATIONS LTD.

All rights reserved. Printed in China.

91-003837-040-100